



ULTRAZVUK diagnostika



$$\lambda = \frac{c}{\gamma} = c \cdot T$$

$$I = p_e v_e$$

$$z = \rho c$$



Infrazvuk

Zvuk 16 Hz-20 kHz

Ultrazvuk nad 20 kHz

$$p_0 = \rho c \omega u_0 = \rho c v_0$$

c- vzduch 340 m/s

c - voda 1500 m/s

z - akustická impedance

Pro 20 kHz je vlnová délka 7,5 cm

Pro 1 MHz je vlnová délka 1,5 mm



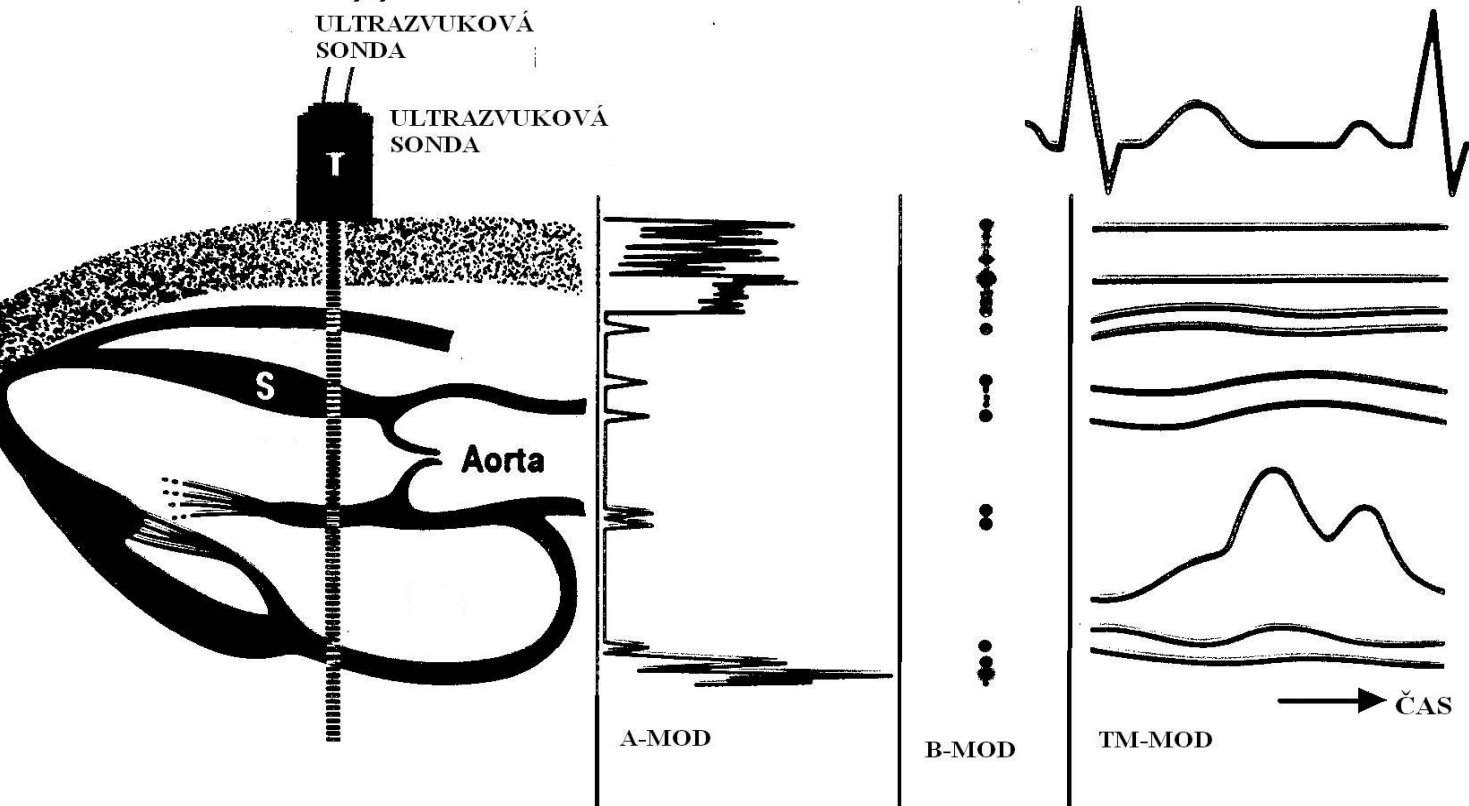

Obraz 1 rozměrný
 Reálný obraz obraz
 2D složením řadek
 B-modu

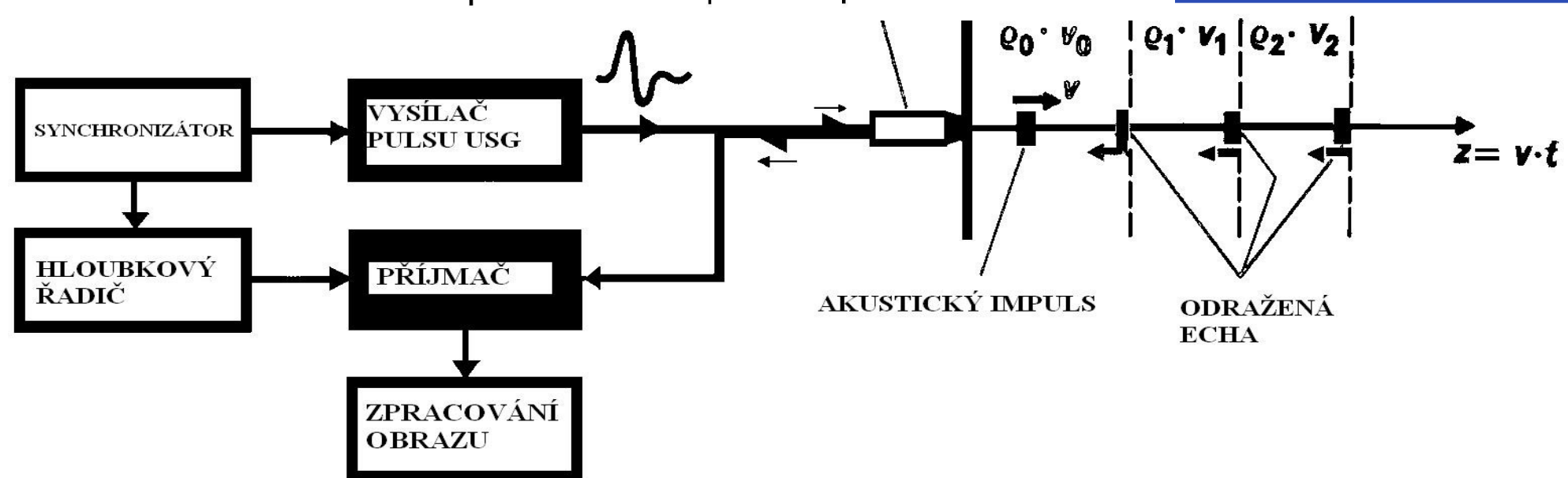

Vytvoření obrazu.

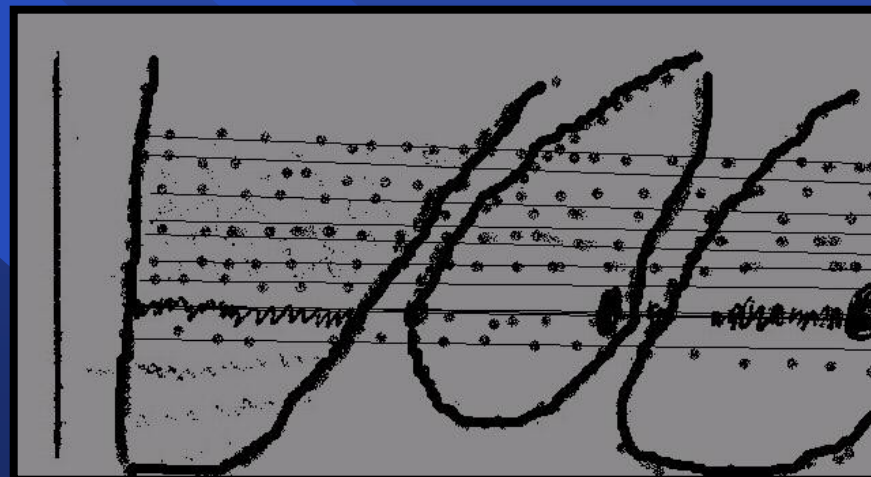
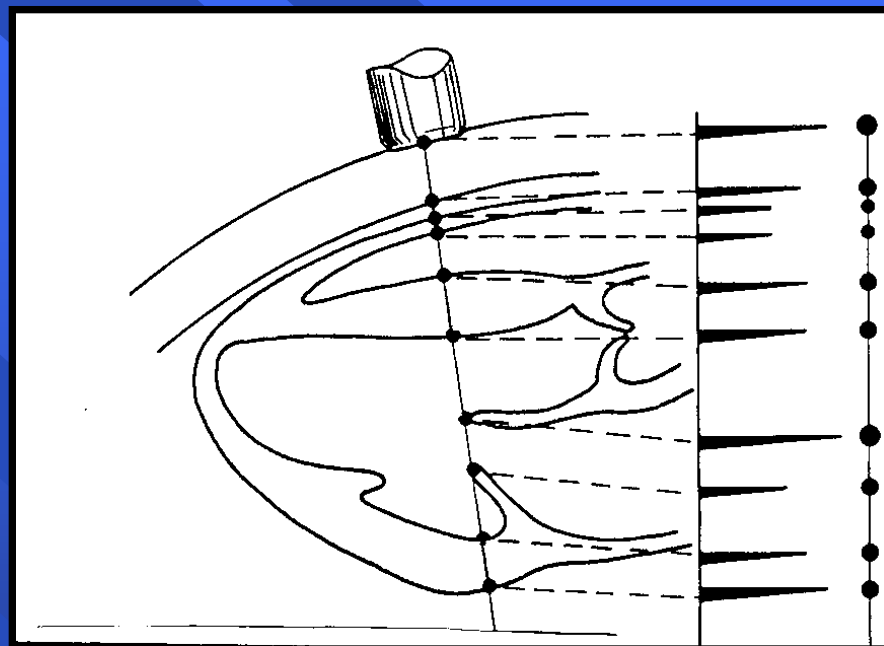
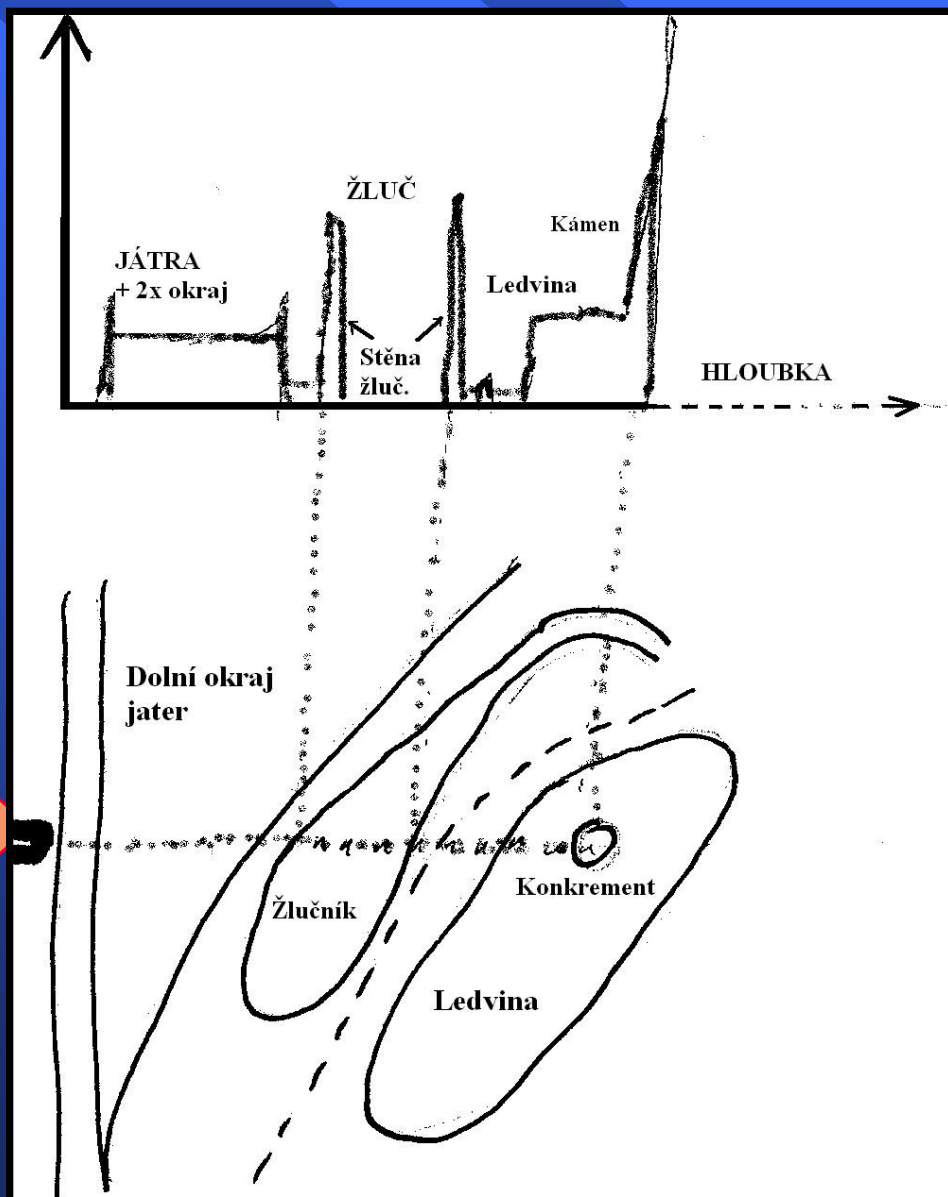

Sonografie

B-zobrazení - dynamické

UZ sondy pro dynamické B-zobrazení: elektronické a mechanické (historie), sektorové a lineární

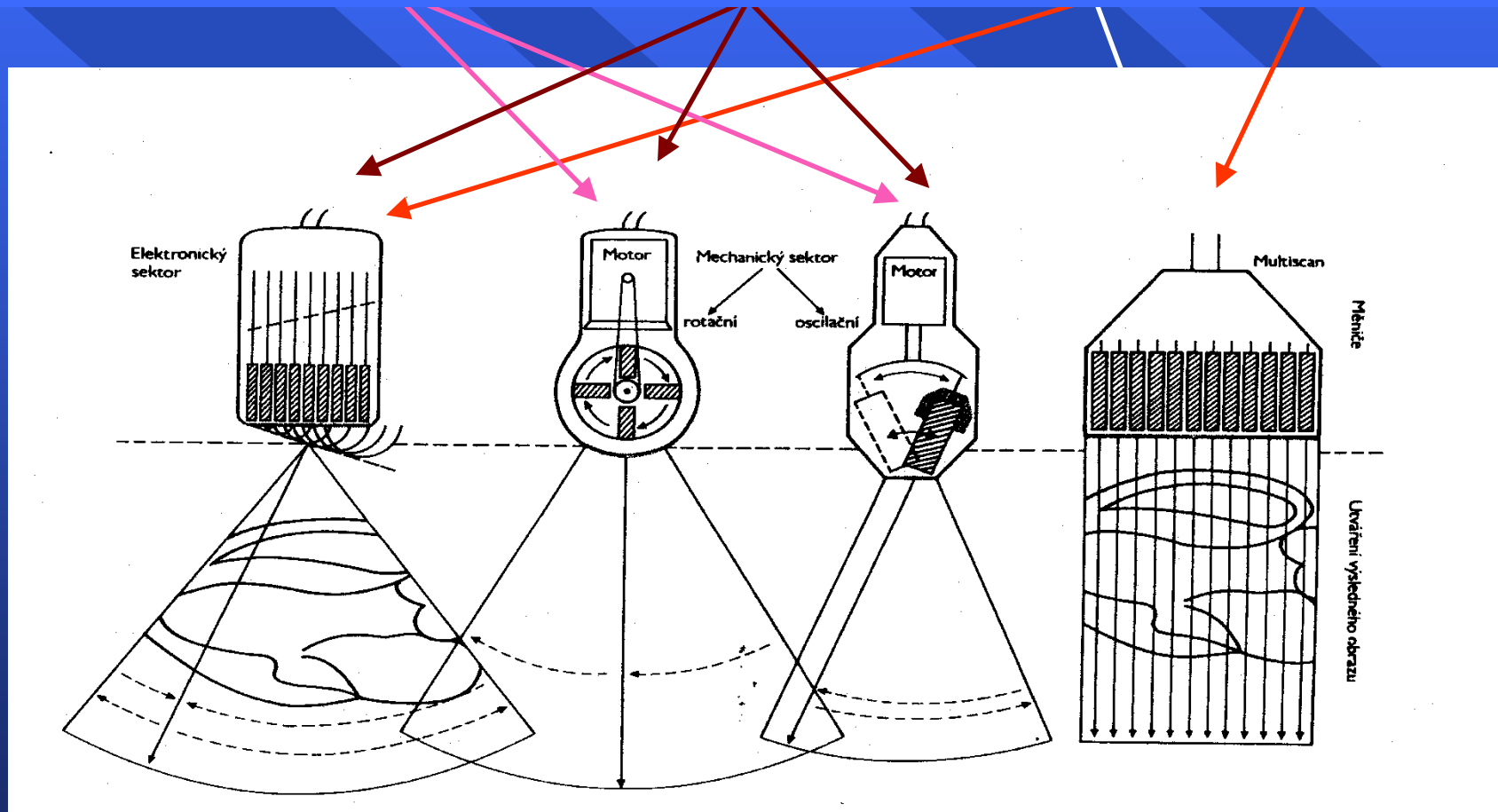

Dutina břišní je často vyšetřována pomocí **konvexní sondy** – kombinace sondy sektorové a lineární.



Principy obrazu A a B-mod

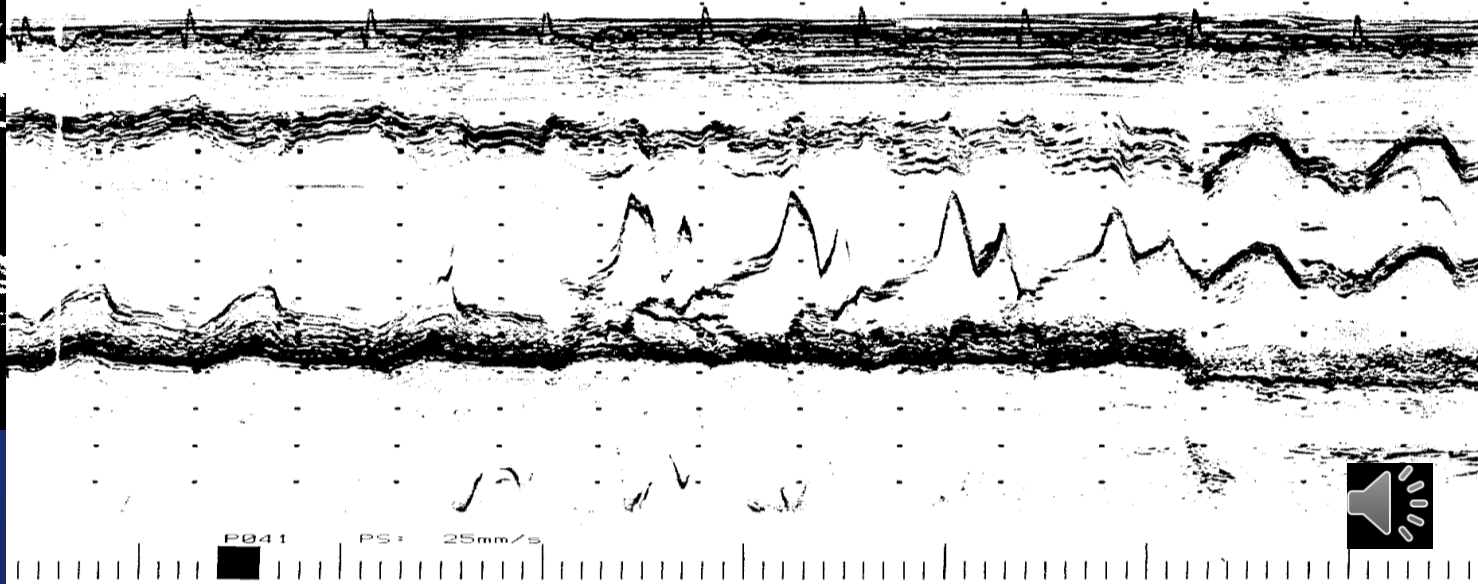
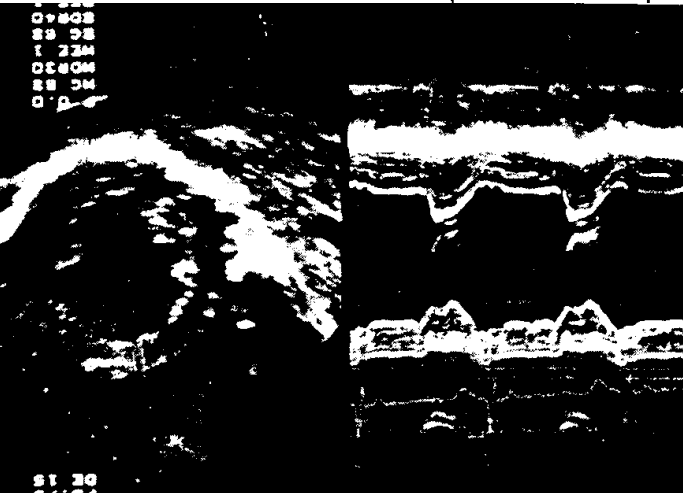
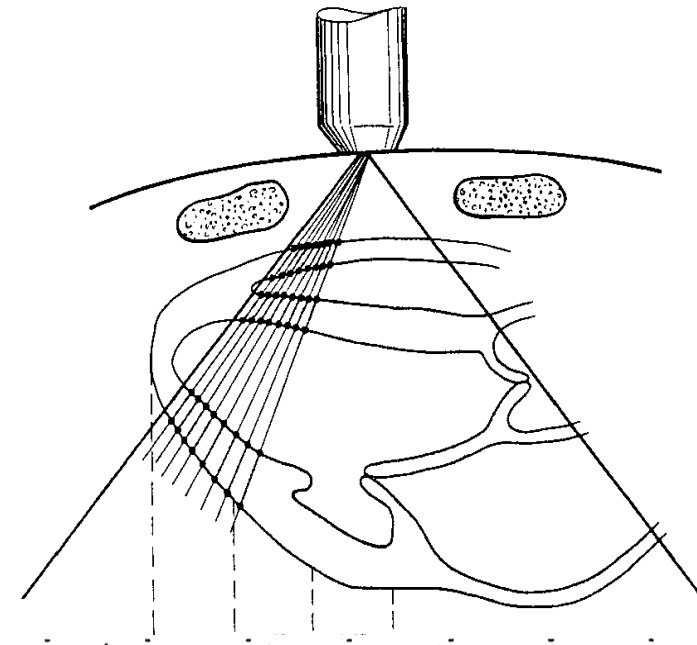
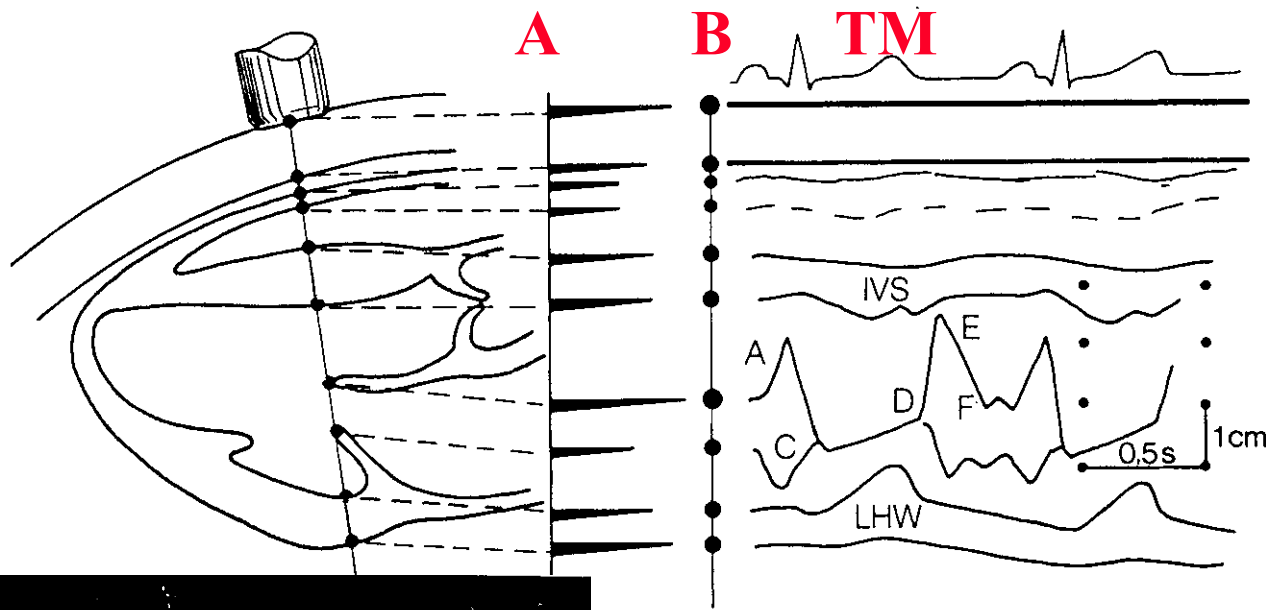

Prostorová orientace sondy 1

Rovina A a rovina B kolmé
vzájemně

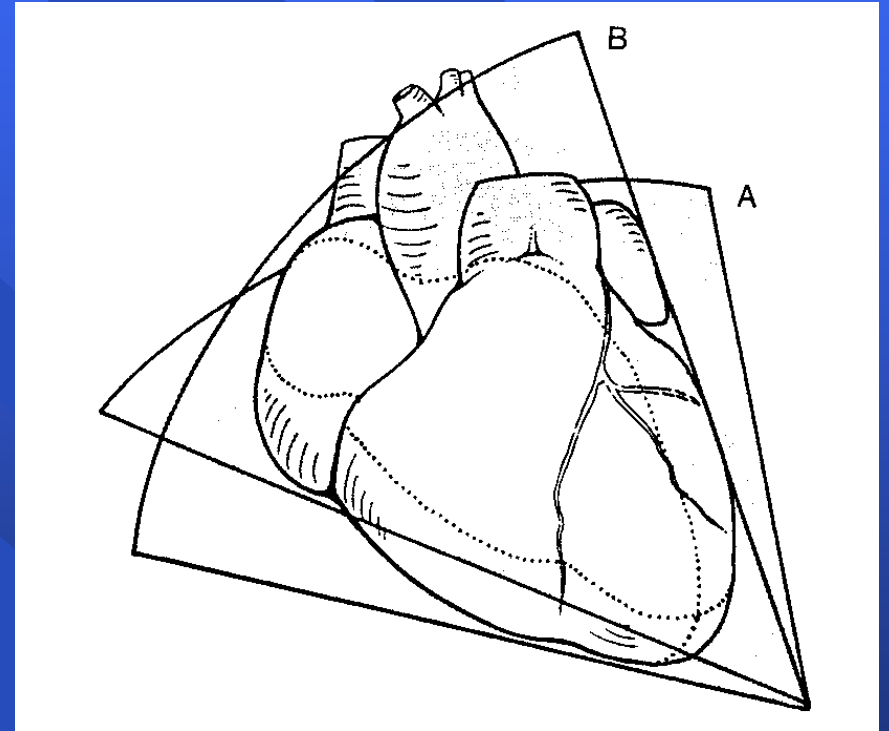
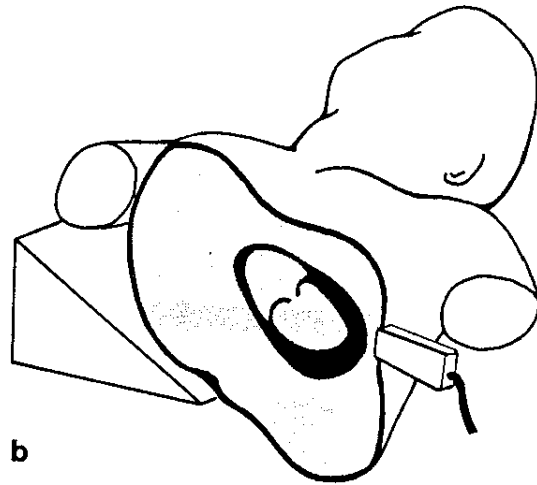
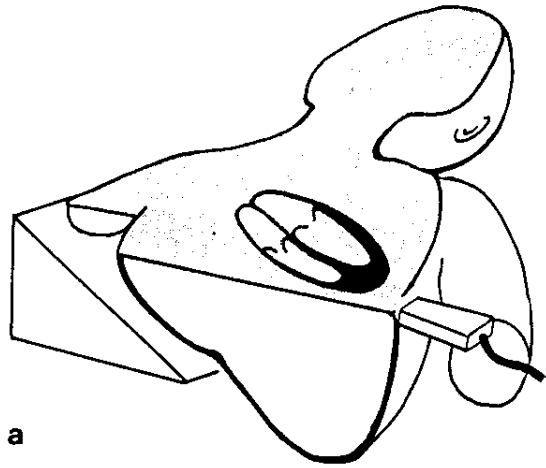

Prostorová orientace sondy 2

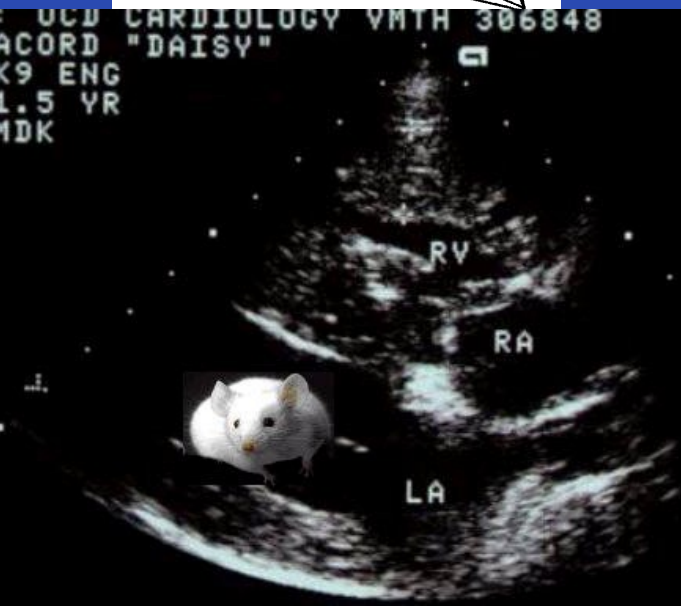
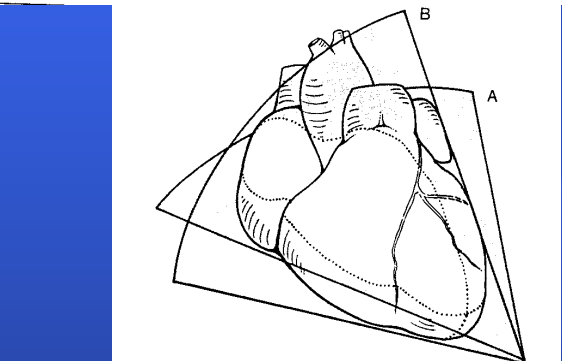
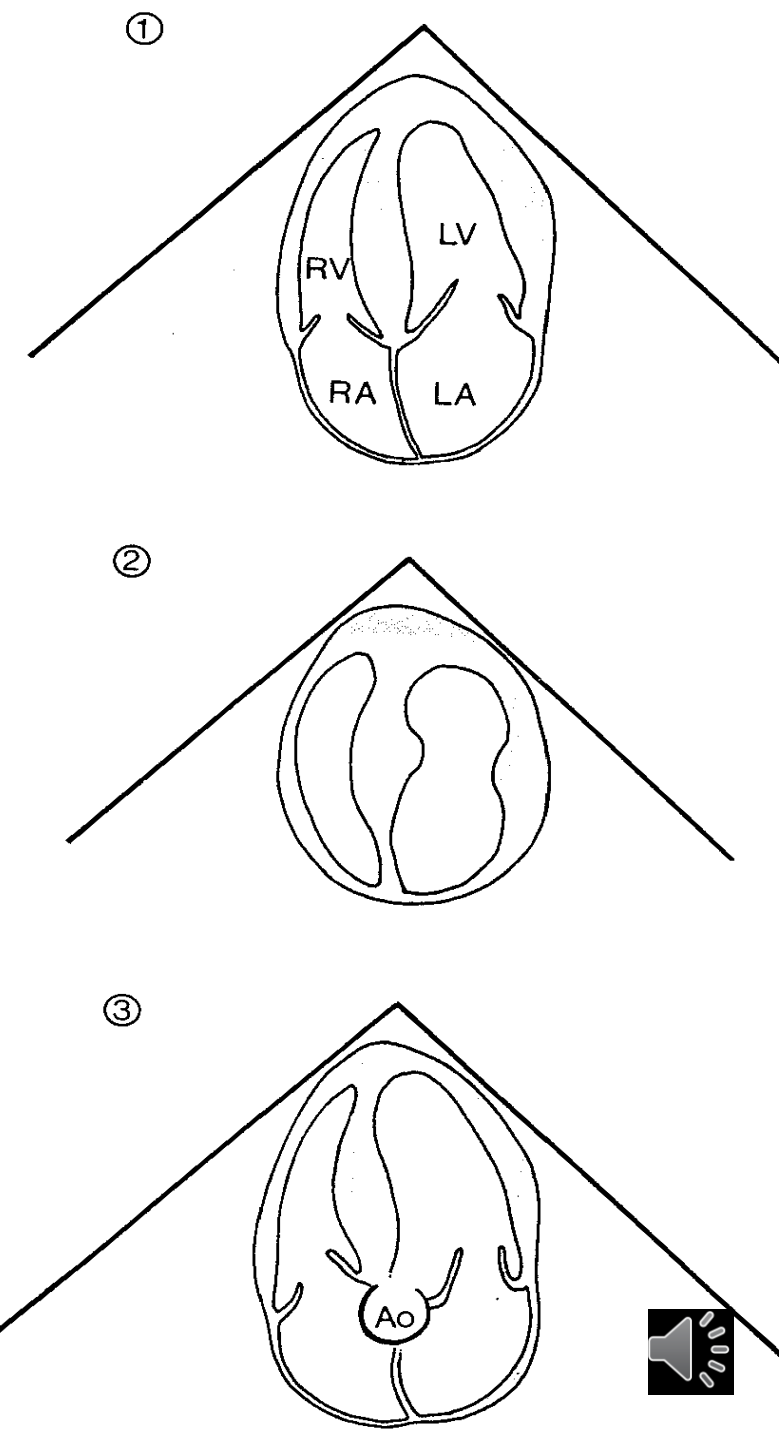
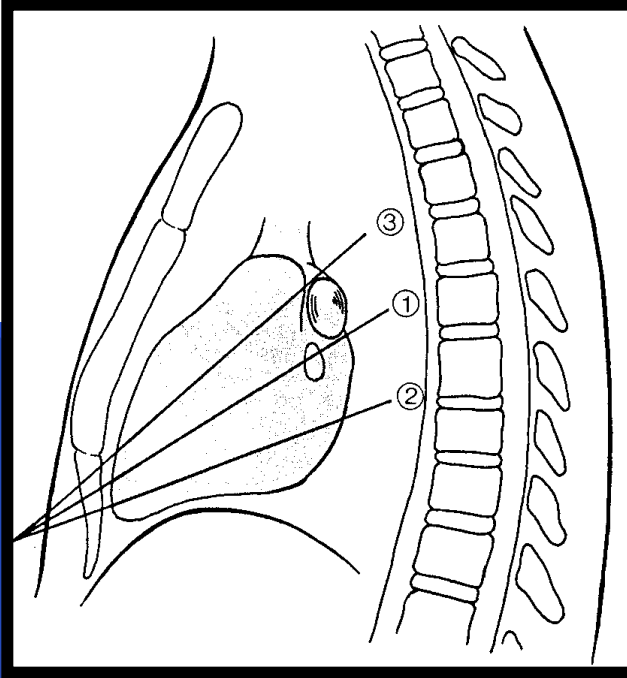
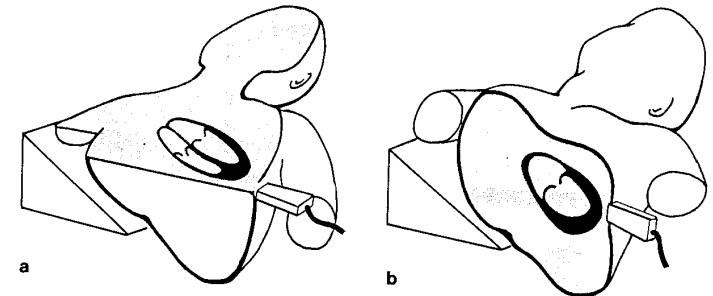

*V komoře
je
myš*



Dopplerův jev 1842 – *Karlovo náměstí*

$$f_d = f - f_{zd}$$

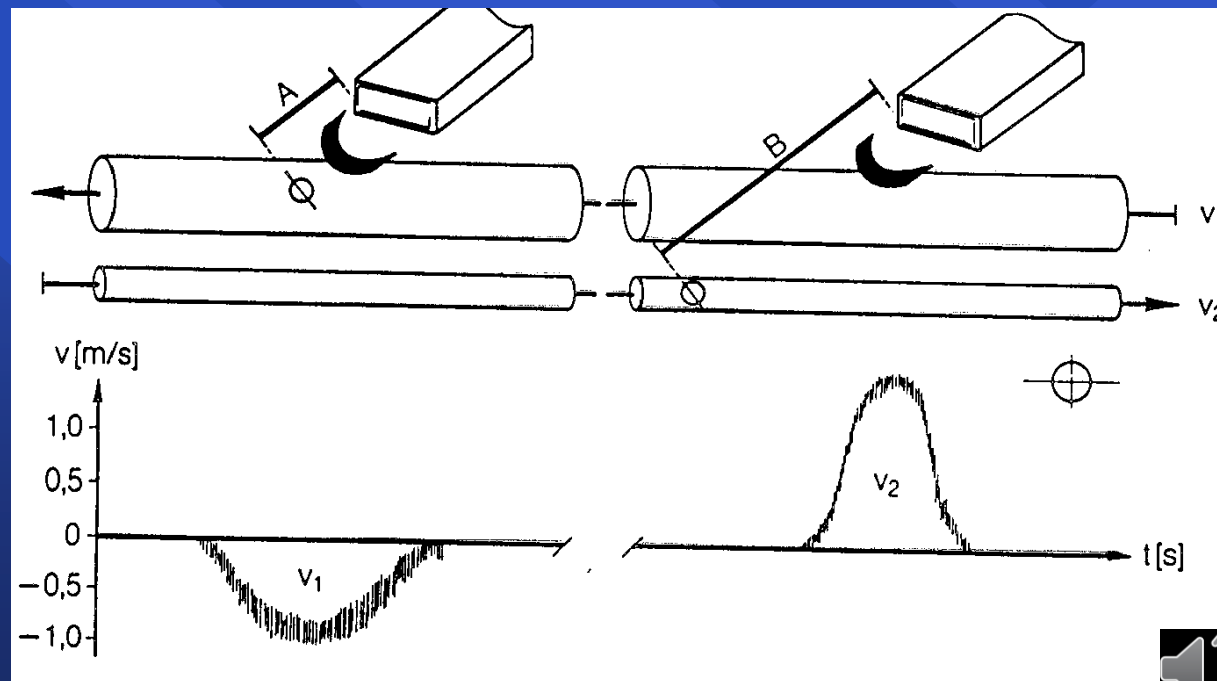
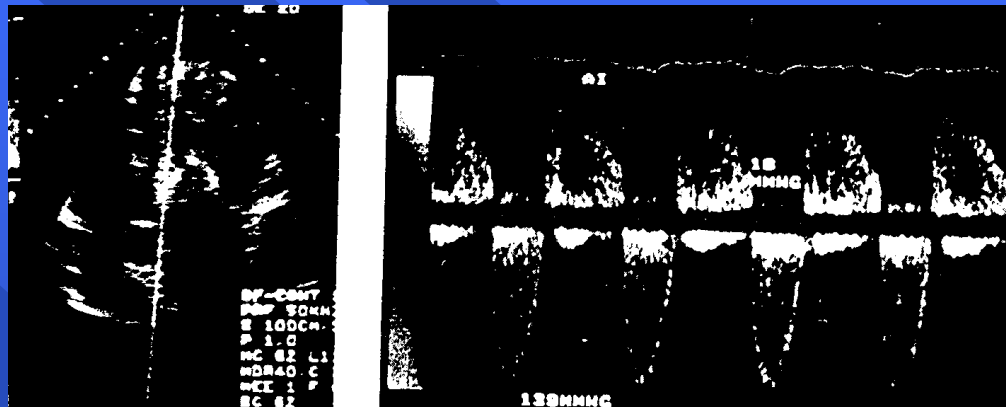
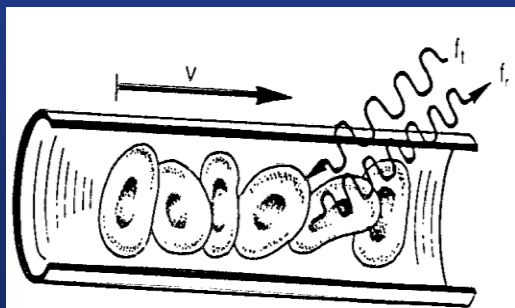
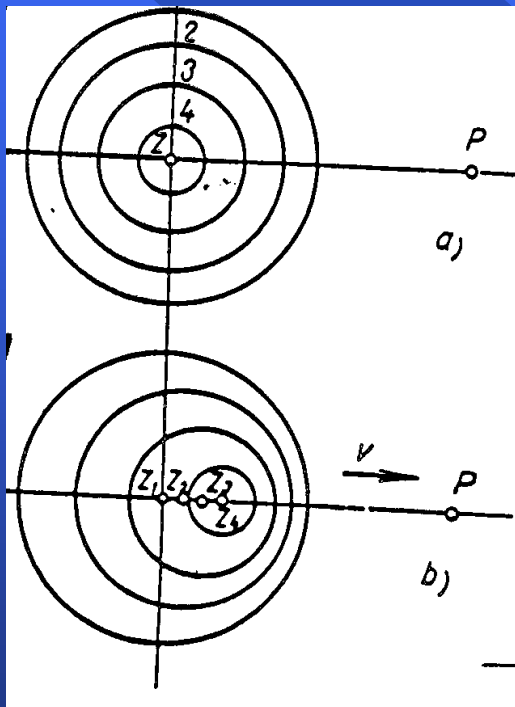

Ultrazvuk - diagnostika

- Rutinní metoda od 1953
- Od 1980 v klinické praxi u nás
- 3,5 až 7 MHz frekvence
- Pozor na kosti a vzduch
- Doppler měření průtoků
- Tomografie 2D, 3D a 4D
- Možnost ihned vyšetřit a neinvazivně



Historie piezoelektrický jev (bratr Jacques)



Pierre Curie
1859 - 1906



Lorentz, Einstein and Langevin in 1927

*Hydrofon
terapie*

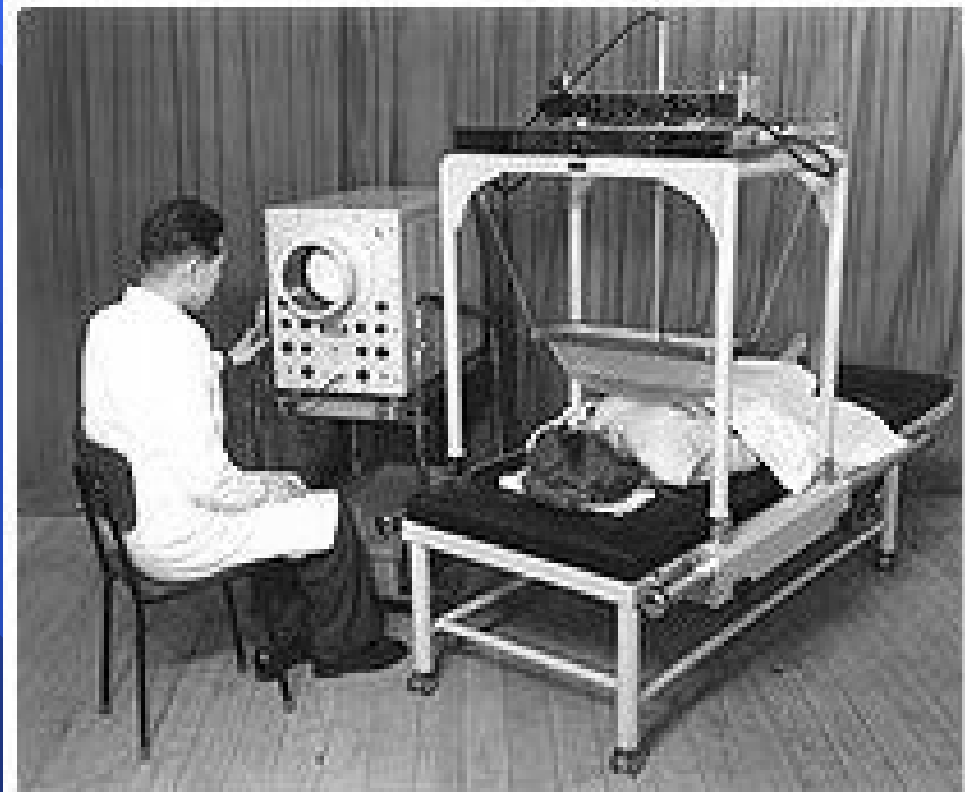
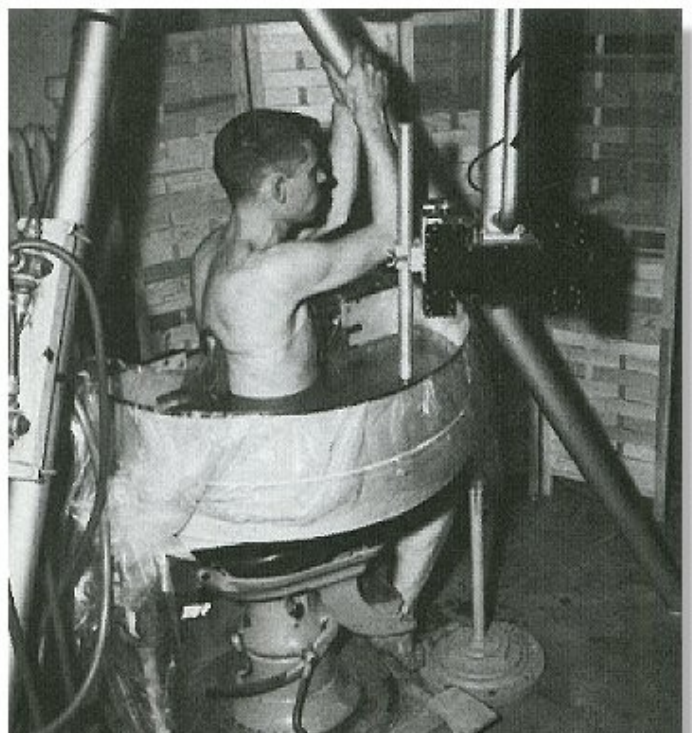

The water-bag B-mode scanning system, the SSD-1, from Aloka in 1960



Data – nejsou k zapamatování

(cit. Jára Cimerman)

- *Titanik v roce 1912 odstartoval vývoj sonarů a měsíc po jeho potopení první patent.*
- *1930 – první metalografické pokusy,*
- *1950 – zlepšená elektronika, vysílače a přijmače, A-mod
moc autorů, Douglas Gordon, JC Turner, van Mayneord and Lars Leksell*
- *1940 – Karl Theodore Dussik ve Vídni, neúspěch*
- *George Ludwig (Pennsylvanie)*
- *John Julian Wild (Cambridge) univer., v roce 1942
emigroval do Minneapolis 1949 A-mod*



Játra a pravá ledvina



Cysta ledviny



2-D arrays with focusing in two planes

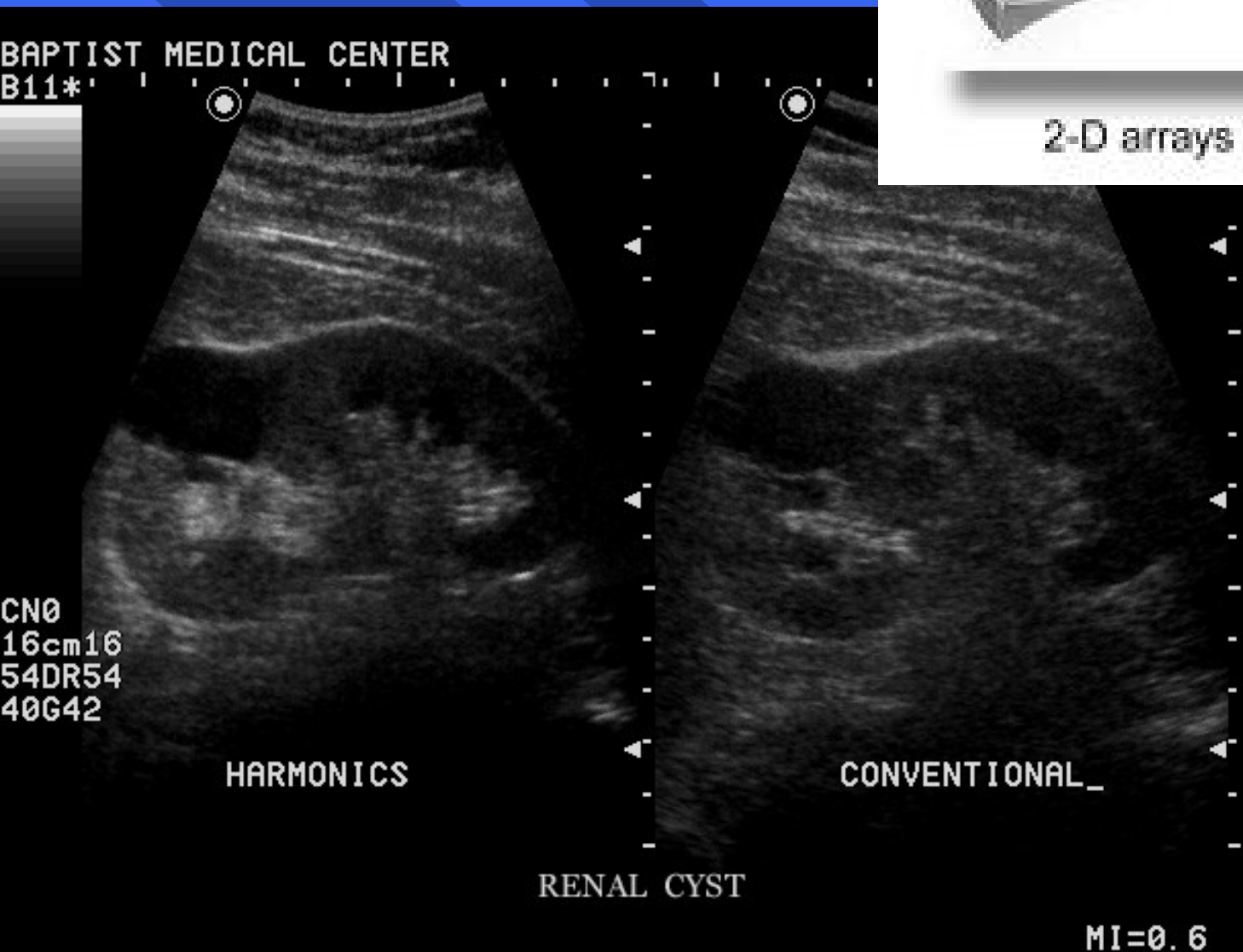

2D a 3D obraz plodu

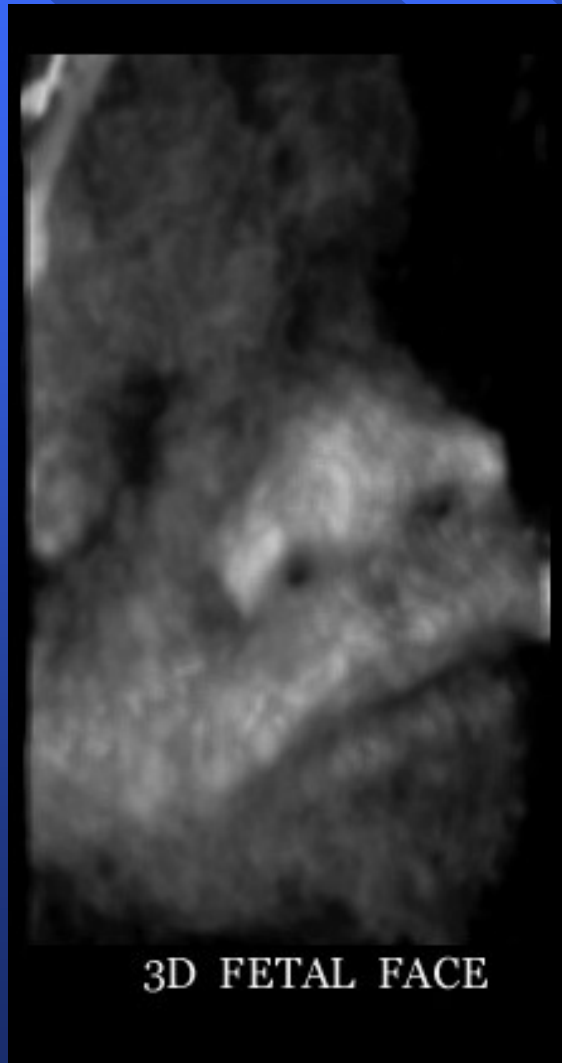

3D obrazy

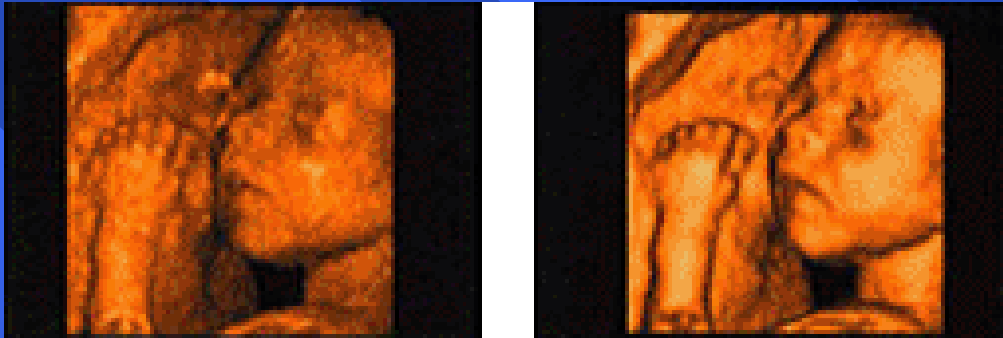

29 týden
těhotenství



Winnipeg 700 BT00
3 +1:50:16

6cm 739L
FET HRT
CINE 0313
34G
63DR
E3 MD* A4

Komory srdce

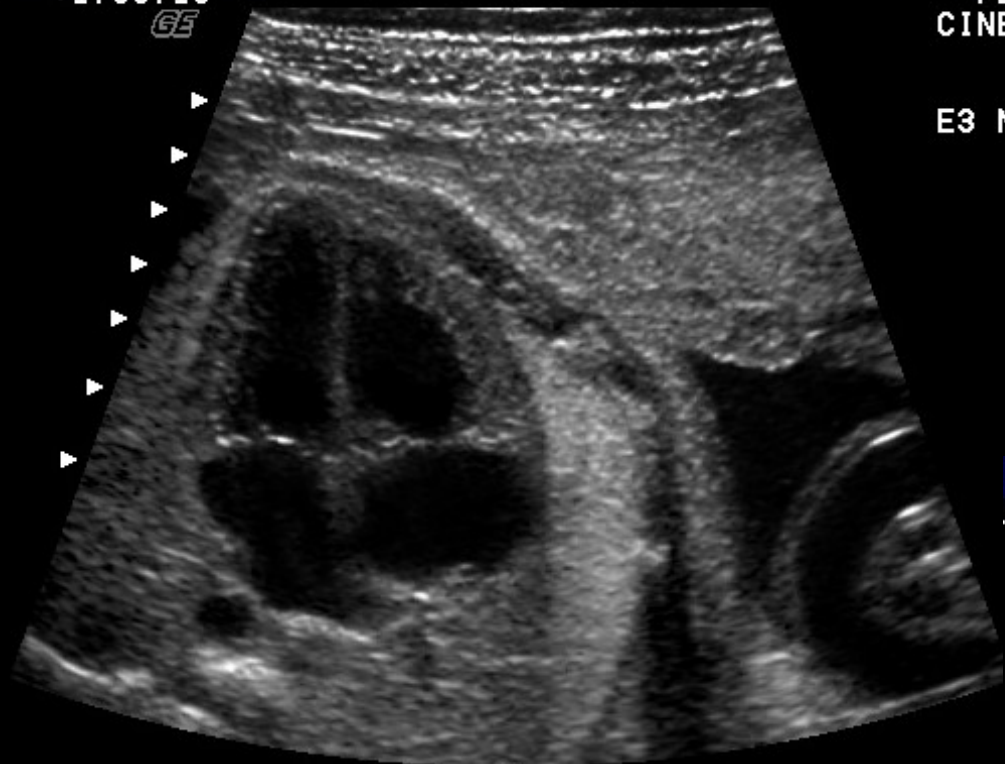

4 CHAMBER FETAL HEART
TIS<0.4 MI=0.7 A0=44%

Winnipeg 700 BT00
1 +1:50:16

GA(EDD)=27W0D 12cm M7c
OB-2/3
CINE 0032
16G
78DR
E2 MD* A2



FETAL ABDOMEN

TIS<0.4 MI=0.2 A0=44%

Fetální placenta břišní oblast



3D obraz v 28 týdnu těhotenství



Dopplerovské měření toku

Obecný princip měření toku krve

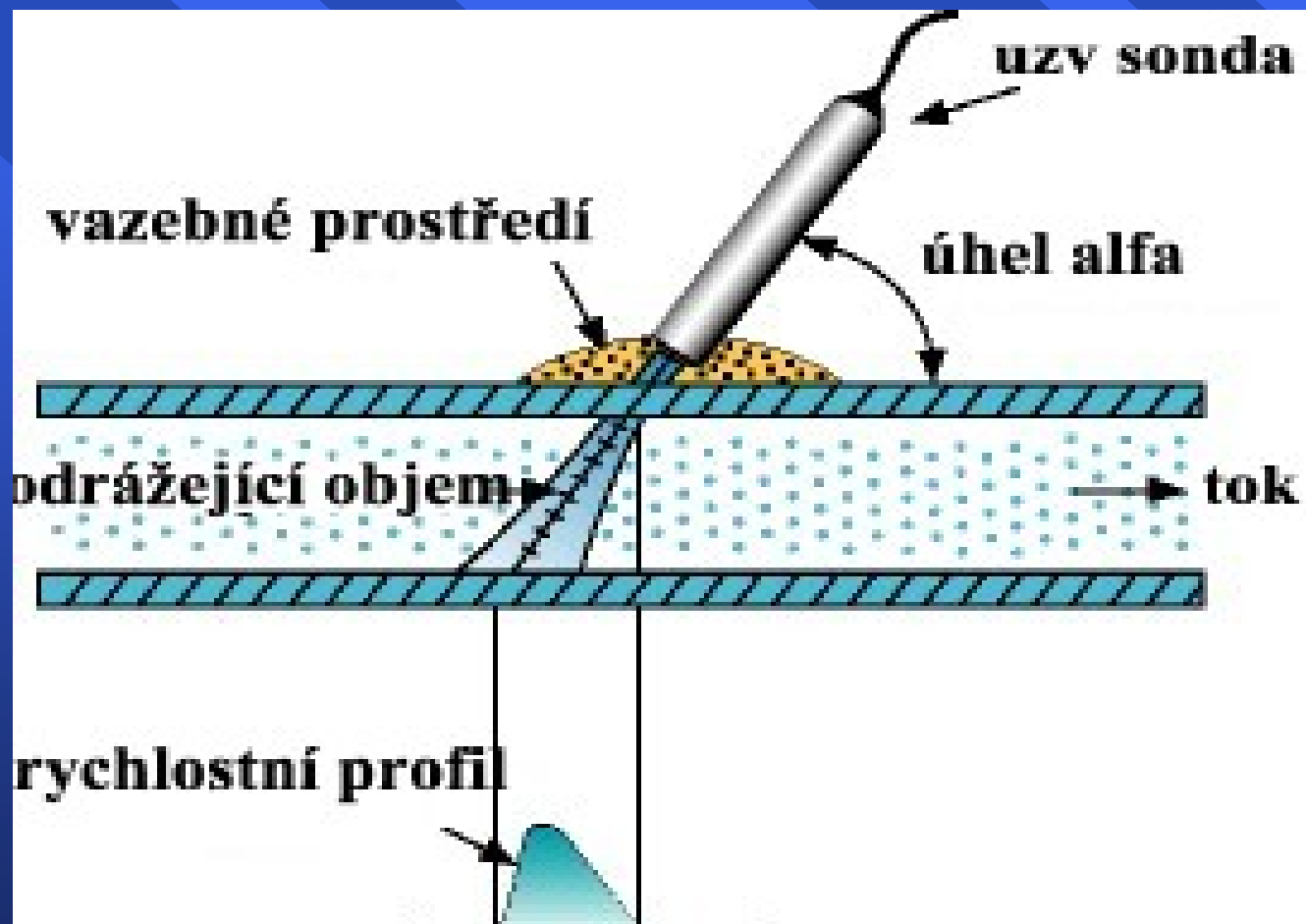

Pokračuje prohlídka obrázků

- U obrazů je podstatná poloha sondy
- Čas je třetí dimenze v klasickém obraze
- Vzduch je třídní nepřítel vyšetření
- MHz zvolené důležité pro benefit
- **Zrádnost v pocitu, že si někdo může myslet, že umí sonografii!!! Zde je pokora před znalostmi na místě.**

