

Světlo

- elektromagnetická
vlna



Optika v klinickém využití

- 1. Odraz a lom
- 2. Disperze
- 3. Interference světla
- 4. Difrakce světla - ohyb
- 5. Polarizace světla
- 6. Koherence vlnění
- 7. Fluorescence, fosforescence
- 8. Absorpce, emise stimulovaná emise.



■ Augustin Jean Fresnel

(1788 - 1827)

1820: příčné vlnění

James Clerk Maxwell

(1831 - 1879)

Heinrich Rudolf Hertz

(1857 - 1894)

1890: získal pomocí kmitavého
elektromagnetické vlny o krátké
a ukázal, že se spojují a odrážejí



ce



Kvantová teorie světla

Max Planck
(1858 - 1947)



Albert Einstein
(1879 - 1955)

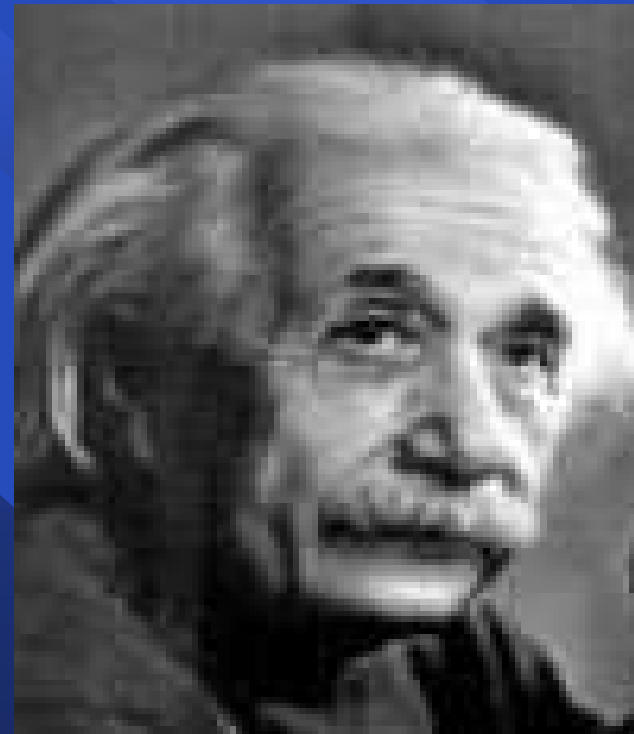

Fotony – elektromagnetické vlny

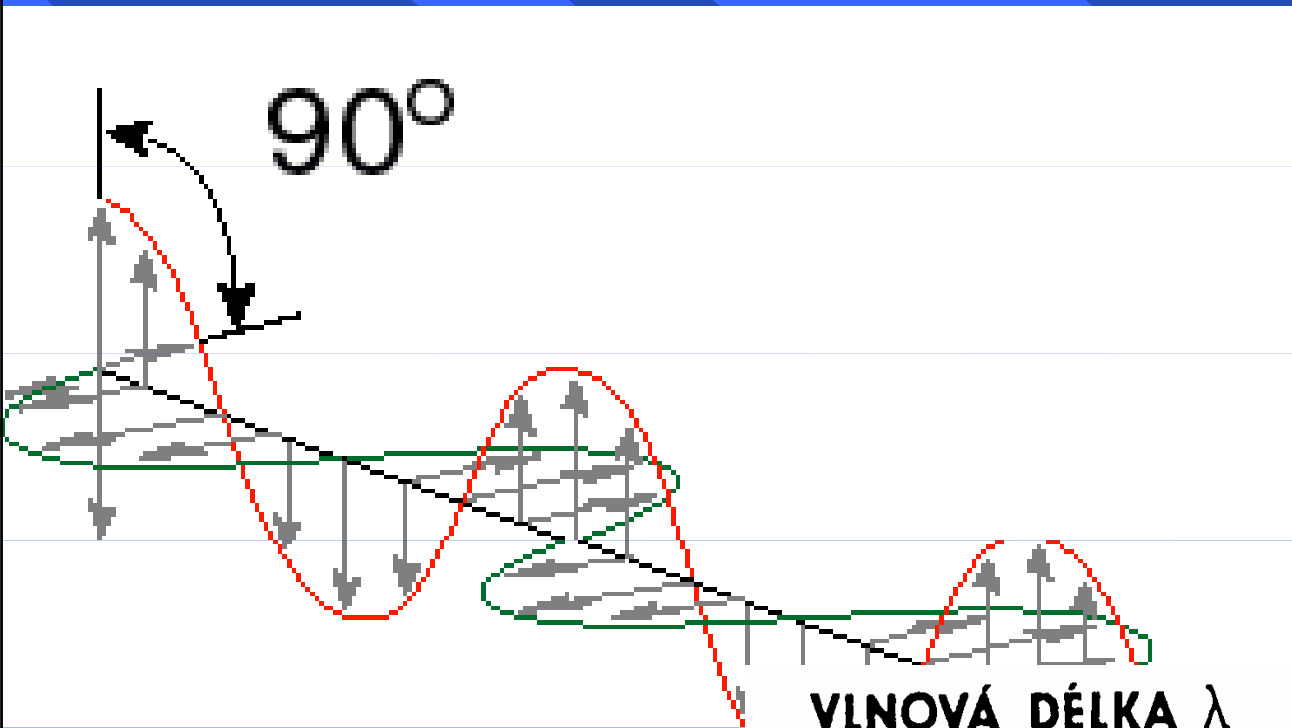

Elektromagnetická
vlna

Elektromagnetické
spektrum

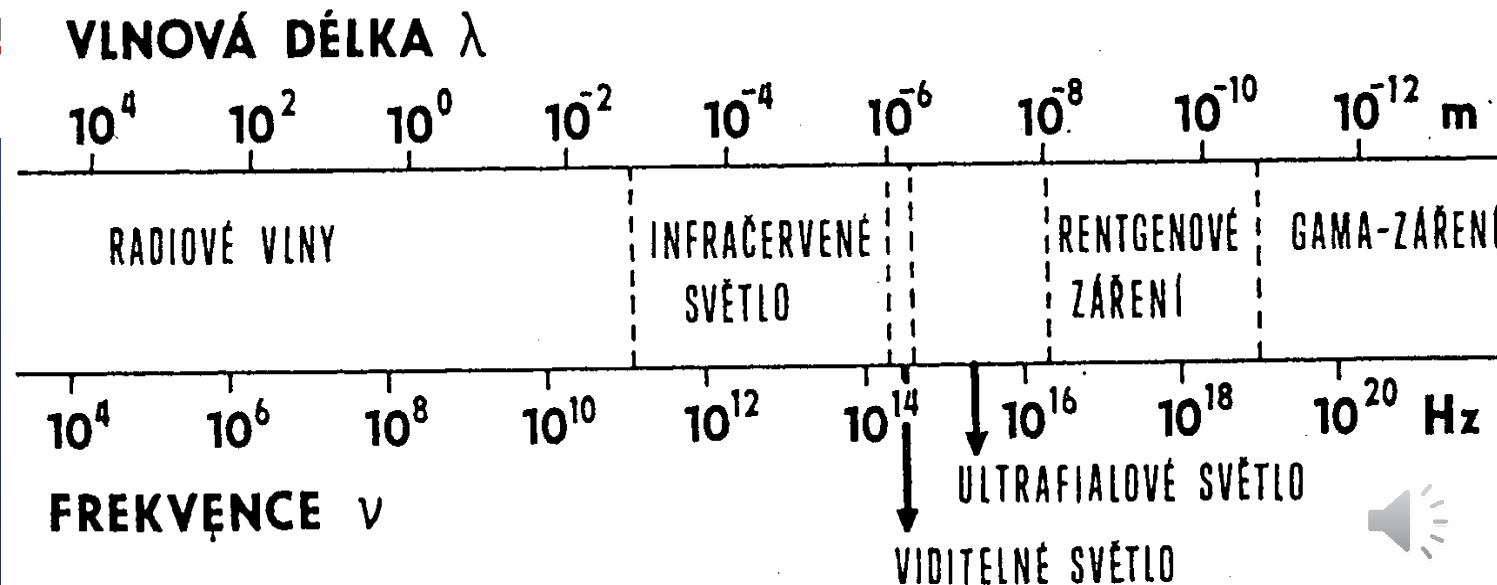

Energie světla

$$E = hf = \frac{hc}{\lambda}$$

■ *Stefanův – Boltzmannův zákon*

$$H = \sigma T^4$$

■ *Wienův zákon*

$$\lambda_{\max} = \frac{b}{T}$$

Energie fotonu viditelného světla zelené barvy o vlnové délce 555 nm a frekvenci $f = 5,4 \cdot 10^{14}$ Hz je velmi malá a podle rovnice činí $3,6 \cdot 10^{-19}$ J = 2,25 eV.

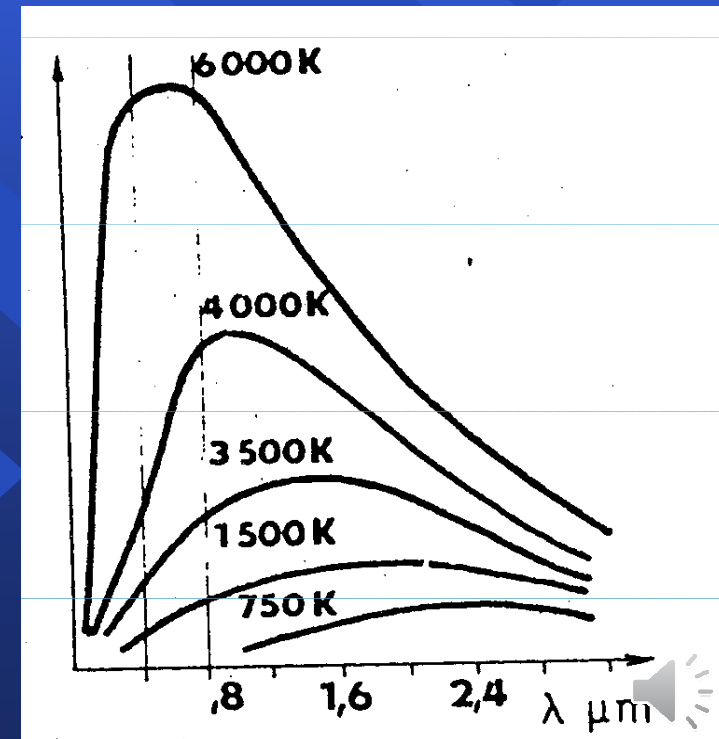

Optika v klinickém využití

teď už jdeme na věc

- 1. Odraz a lom
- 2. Disperze
- 3. Interference světla
- 4. Difrakce světla - ohyb
- 5. Polarizace světla
- 6. Koherence vlnění
- 7. Fluorescence, fosforescence
- 8. Absorpce, emise stimulovaná emise.



1. Odraz, lom a index lomu

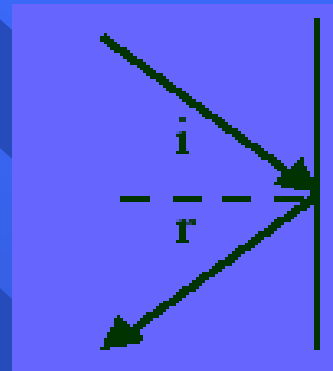
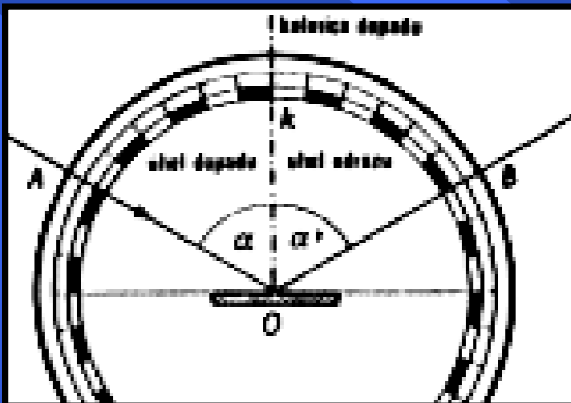

$$n = c/v$$

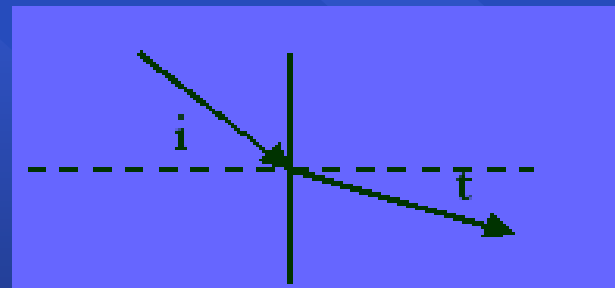
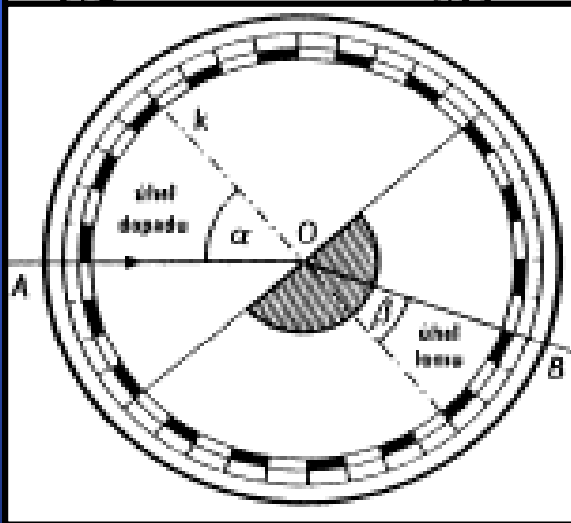

$$\frac{\sin \alpha}{\sin \beta} = \frac{n_2}{n_1}$$

$$\frac{\sin \alpha_m}{\sin 90^\circ} = \frac{\sin \alpha_m}{1} = \sin \alpha_m = \frac{n_2}{n_1}$$

Mezní úhel, totální odraz, jde o 100%



Dvě skla s jiným indexem lomu

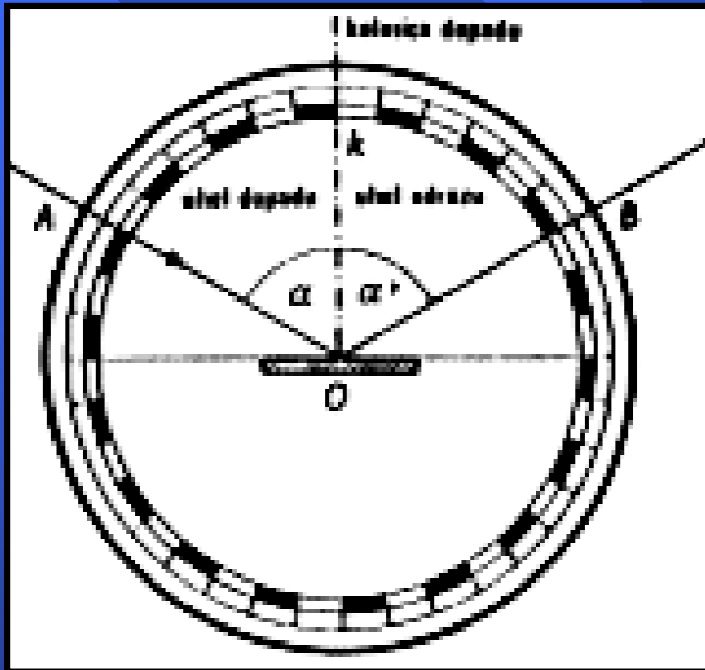

$$\frac{\sin \alpha}{\sin \beta} = \frac{n_2}{n_1}$$

$$n = c/v$$

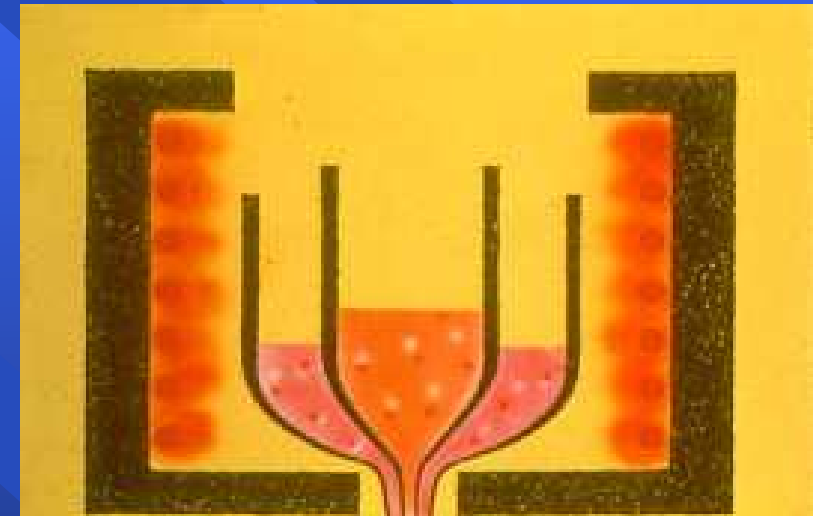

$$\frac{\sin \alpha_m}{\sin 90^\circ} = \frac{\sin \alpha_m}{1} = \sin \alpha_m = \frac{n_2}{n_1}$$

Mezní úhel, totální odraz, jde o 100%



Totální odraz, jedno vlákno

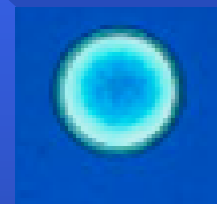
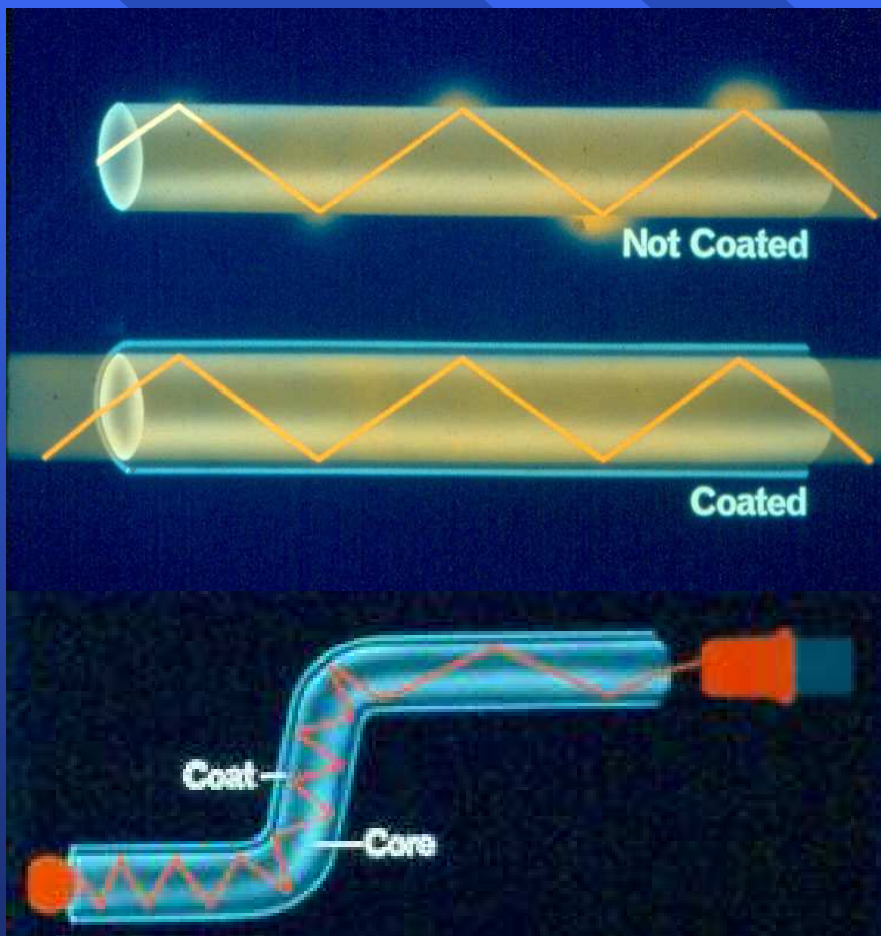
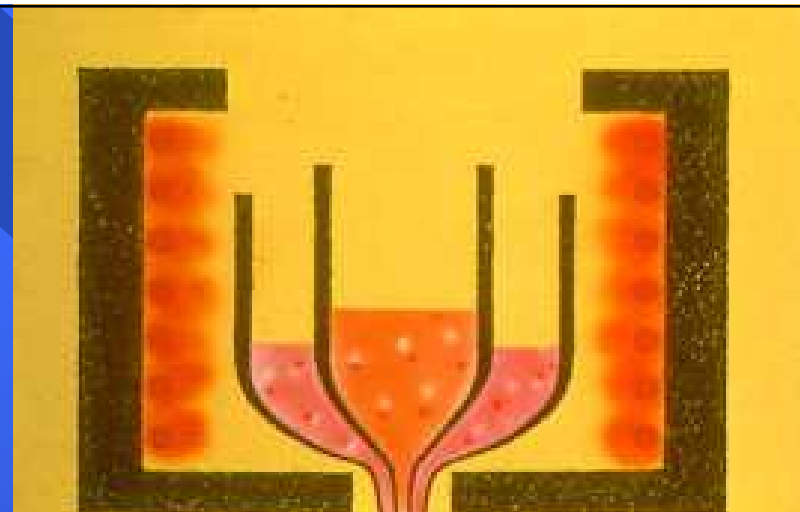

Mikroskopický detail zorného pole

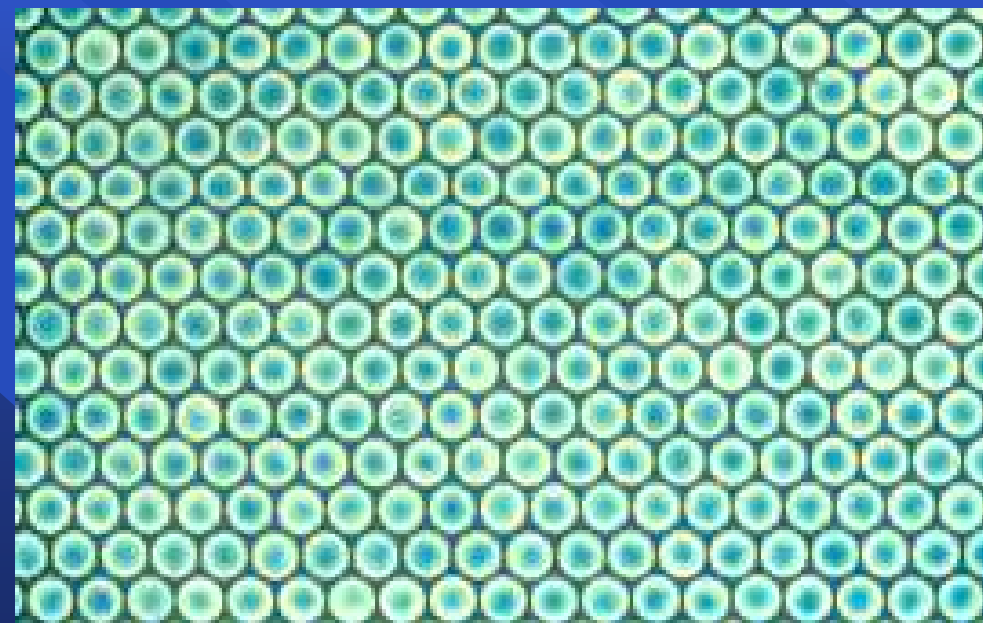



2. Disperze světla

Při lomu světla se rozkládá na jednotlivé vlnové délky.

Příčinou je závislost rychlosti světla v látkách na frekvenci – disperze světla. Při normální disperzi se rychlost světla zmenšuje s frekvencí. Ve vakuu k disperzi nedochází.

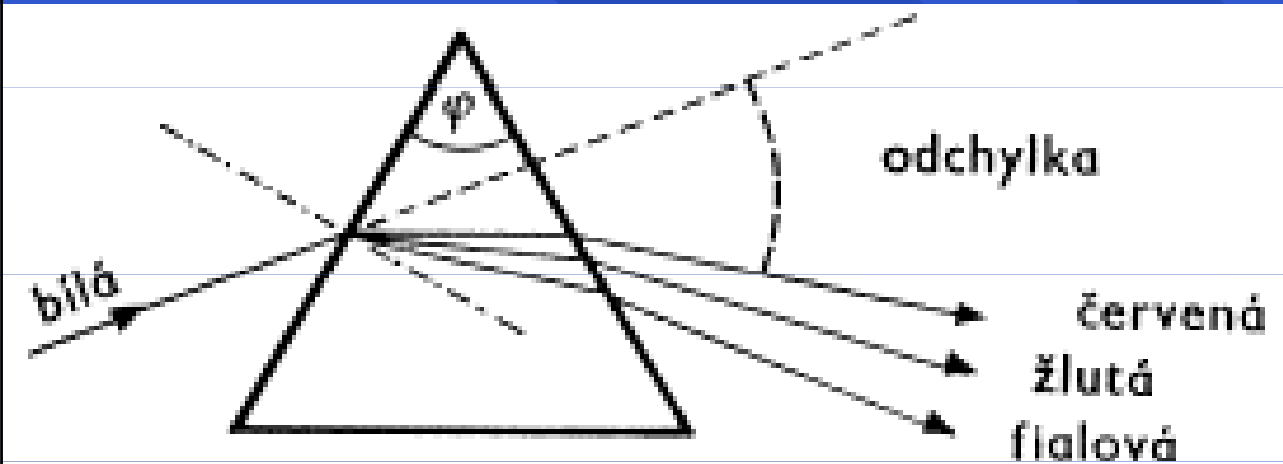

$$f = \frac{c}{\lambda_0} = \frac{v}{\lambda}$$

$$n = \frac{c}{v} = \frac{\lambda_0 \cdot f}{\lambda \cdot f} = \frac{\lambda_0}{\lambda} \Rightarrow \lambda = \frac{\lambda_0}{n}$$

Vlnová délka světla závisí na indexu lomu prostředí

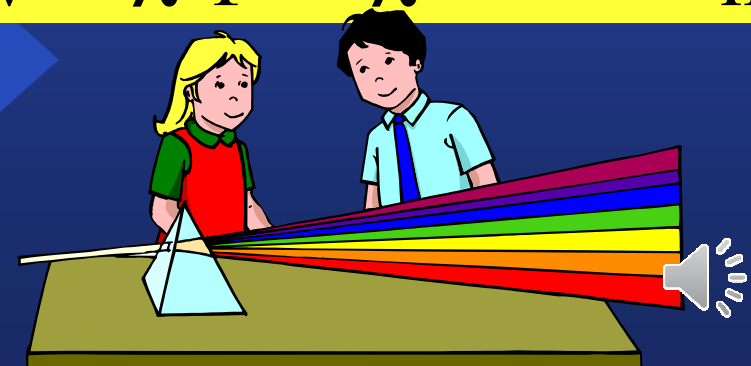

3. Interference skládání světla.

PODMÍNKA KOHERENCE:

- paprsky musí mít stejnou frekvenci
- paprsky musí být navzájem rovnoběžné
- paprsky musí mít na sobě nezávislý dráhový rozdíl.

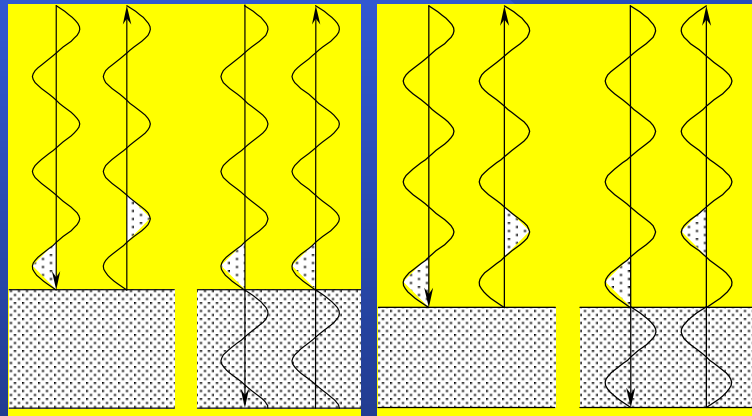

$$c = v \cdot n \Rightarrow l = n \cdot s$$

$$s = 2 \cdot d$$

$$\Delta l = 2 \cdot n \cdot d$$

dráhový rozdíl

$$2 \cdot n \cdot d = k \cdot \lambda$$

Newtonových kroužků lze měřit vlnová délka světla,
nebo kontrolovat opracování.

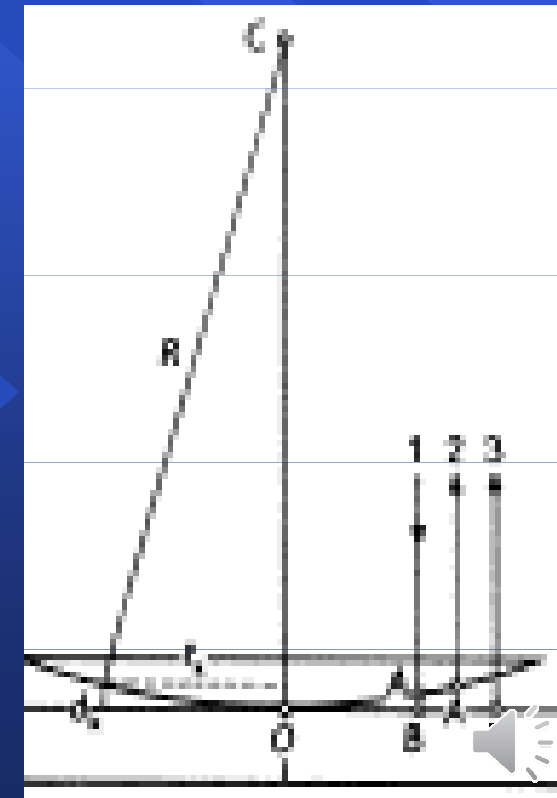
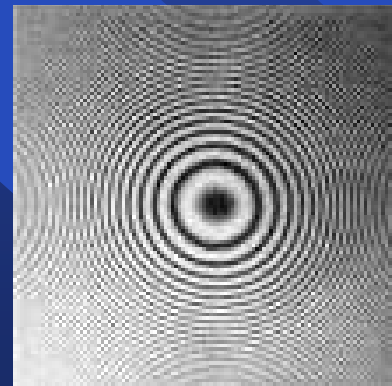

Skládání a ohyb světla



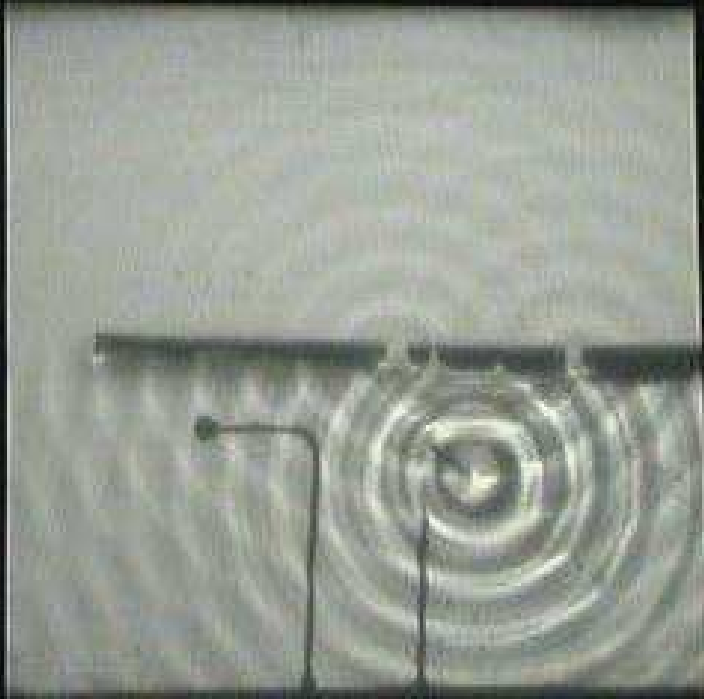
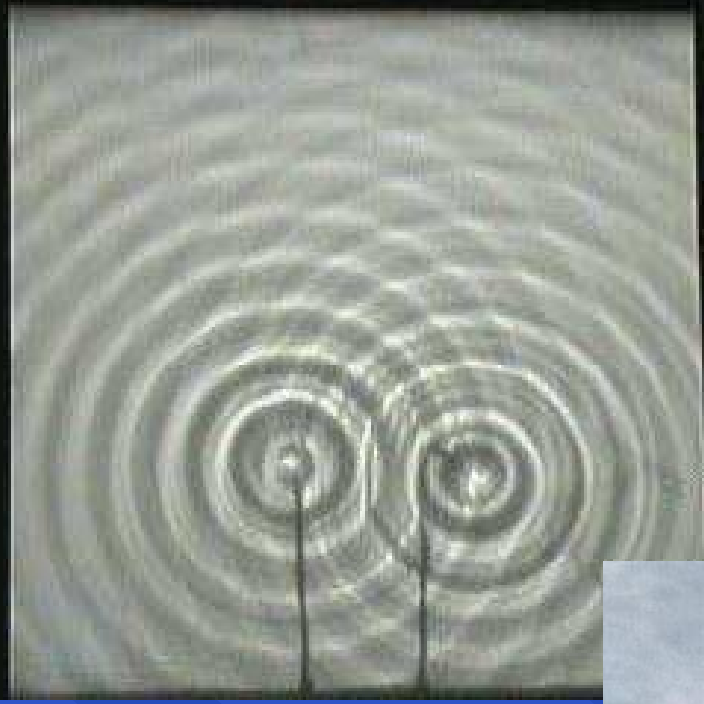

dopadající
vlna



S_0

S_2

S_1

max

max

max

max

max

max

max

max

max

max

max

max

max

max



max

4. Ohyb světla - difrakce

Při ohybu světla dojde k změně směru šíření světla, aniž by se změnilo prostředí → rozdíl od lomu.

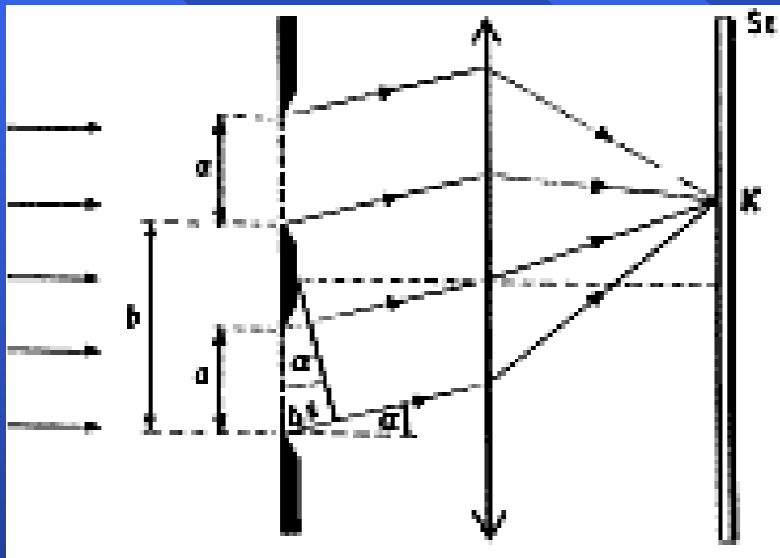

$$b \cdot \sin \alpha = k \cdot \lambda$$

interferenční spektrum.

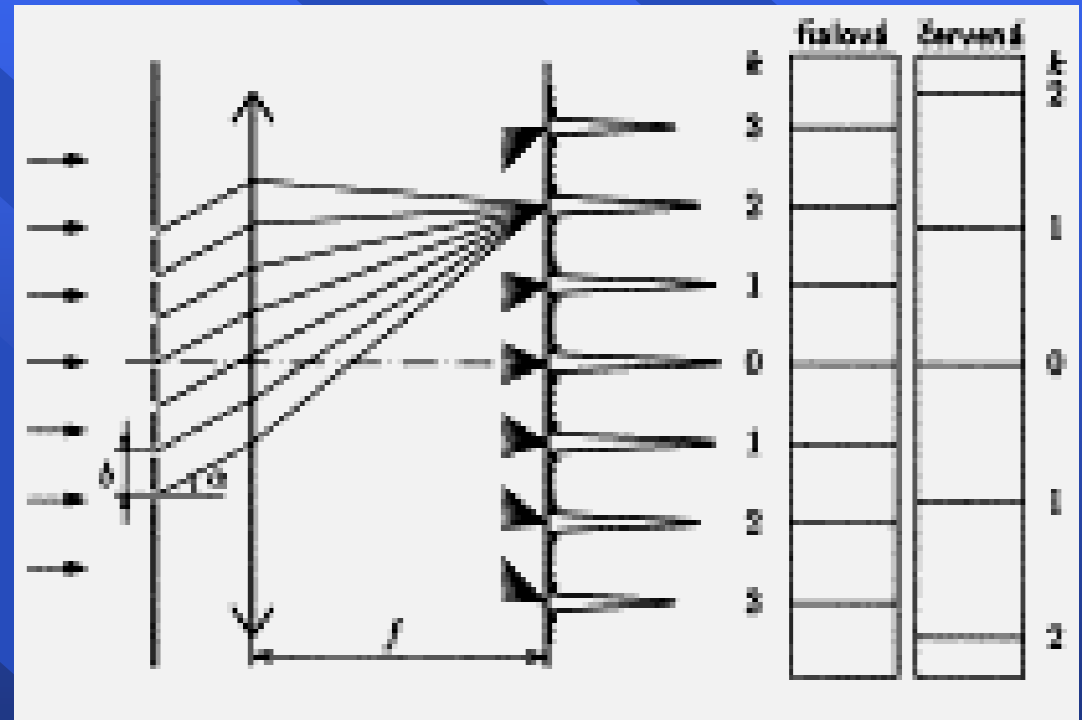

α určuje směr, ve kterém je vzniká maximum a $k = 0, 1, 2, \dots$ je řád maxima



Polarizační jevy



Postupná elektromagnetická vlna:

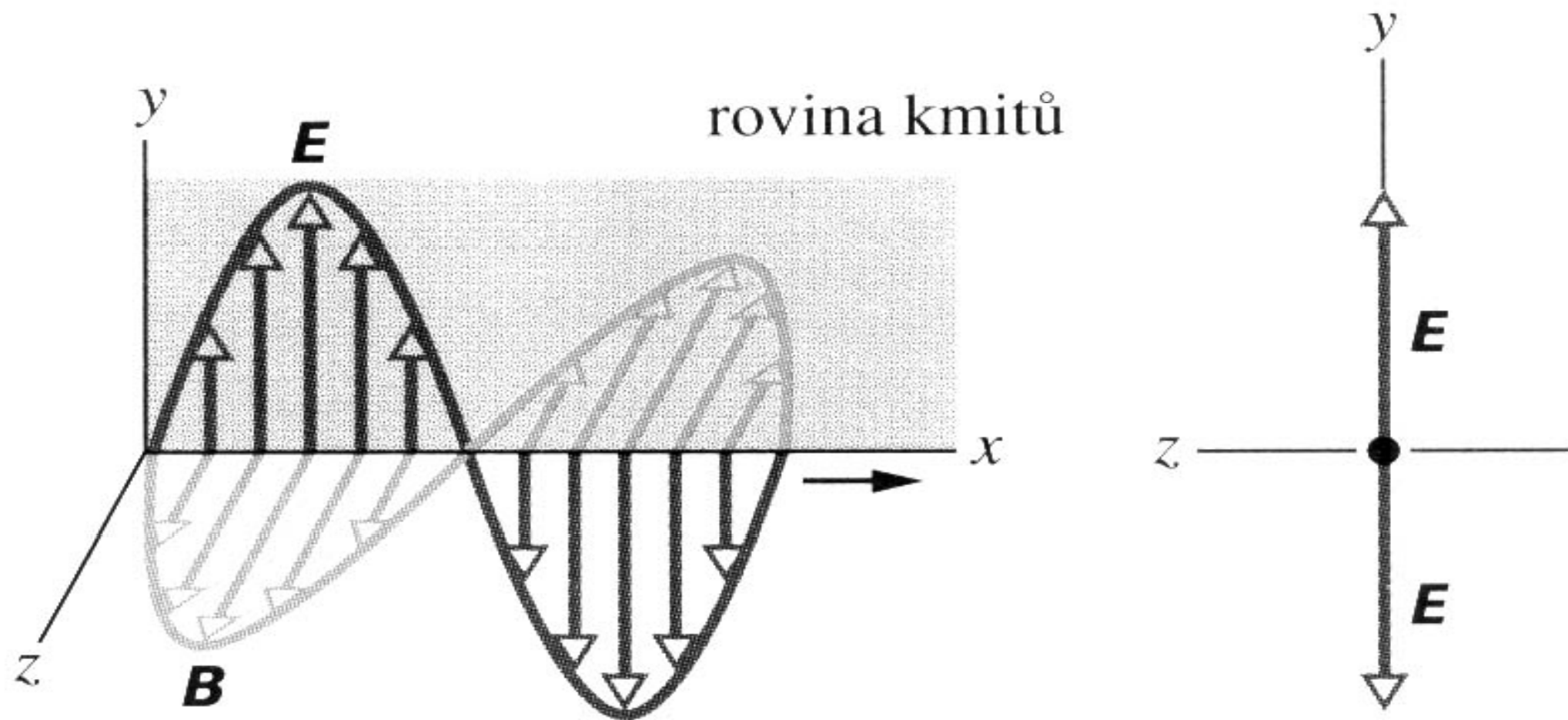

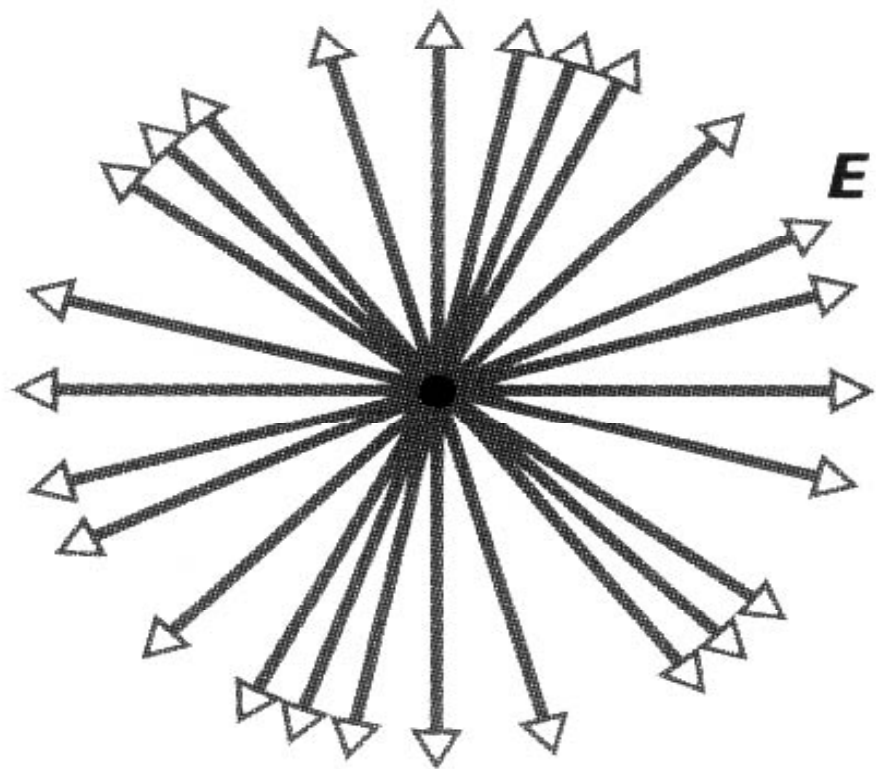

(a)

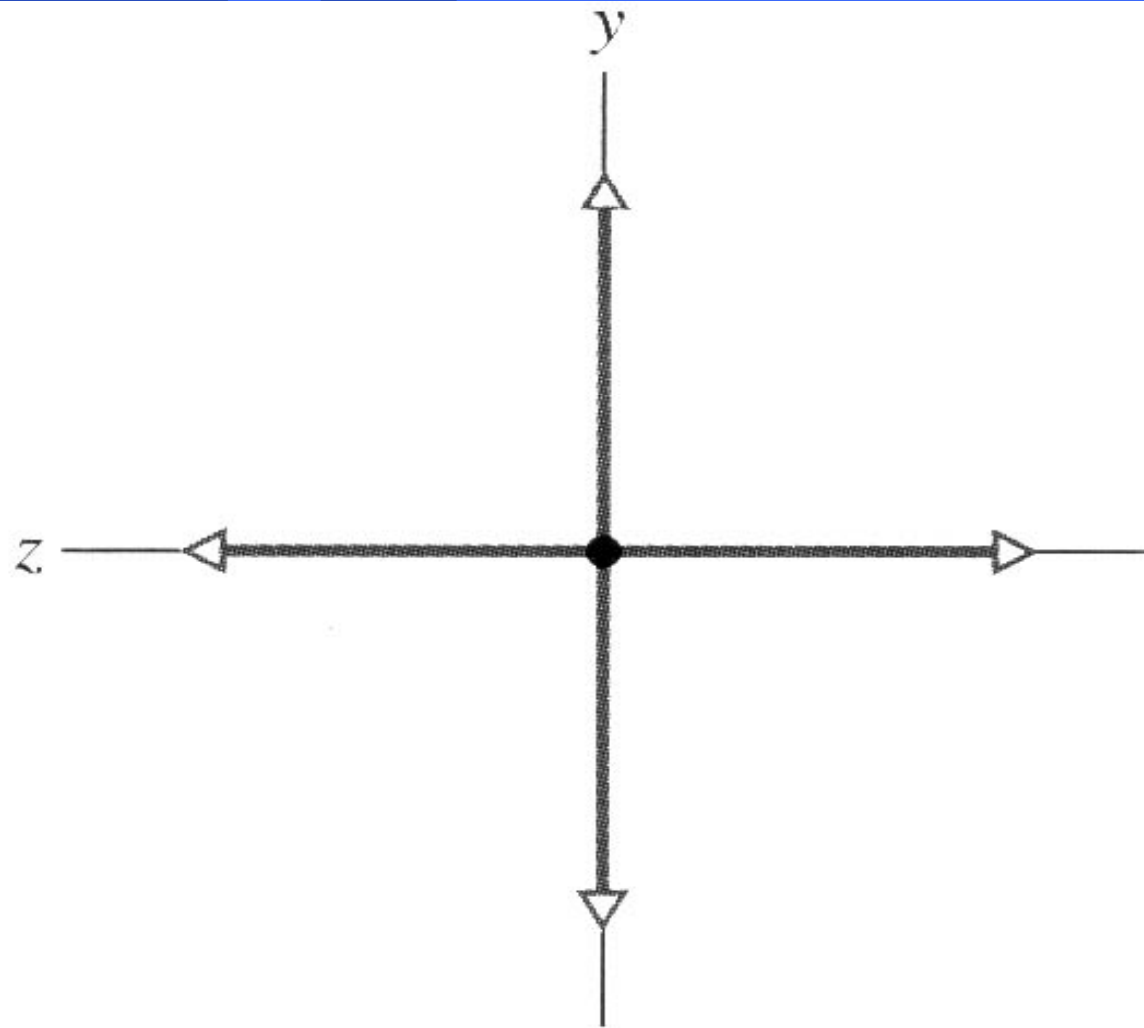

(b)



■ přirozené světlo

(přímé sluneční světlo, žárovka, plamen

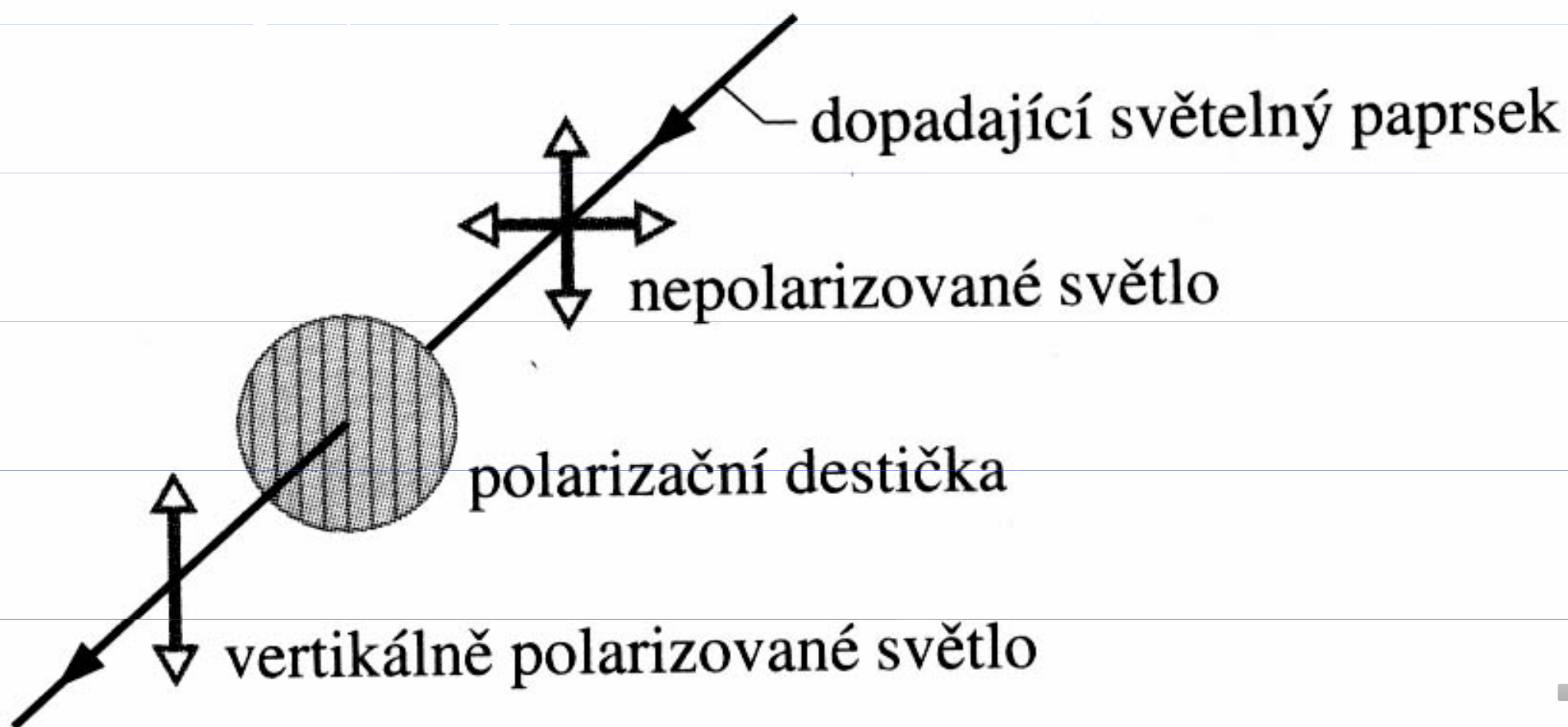

5. Polarizace

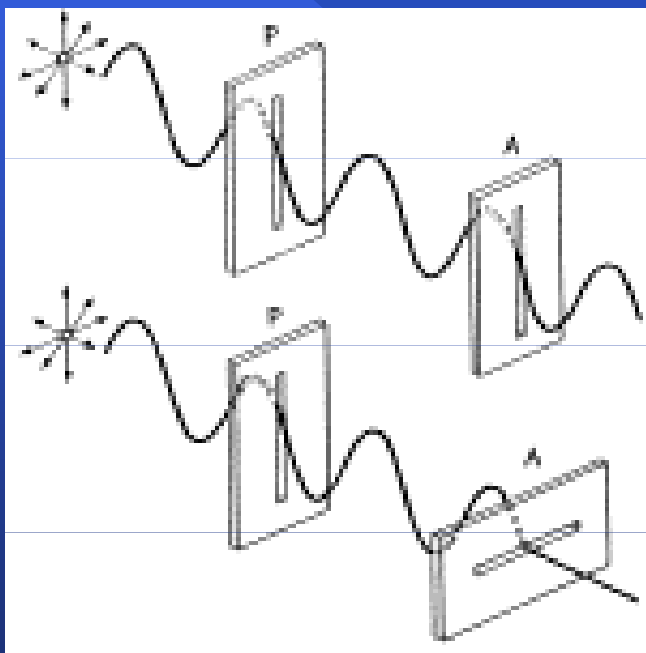
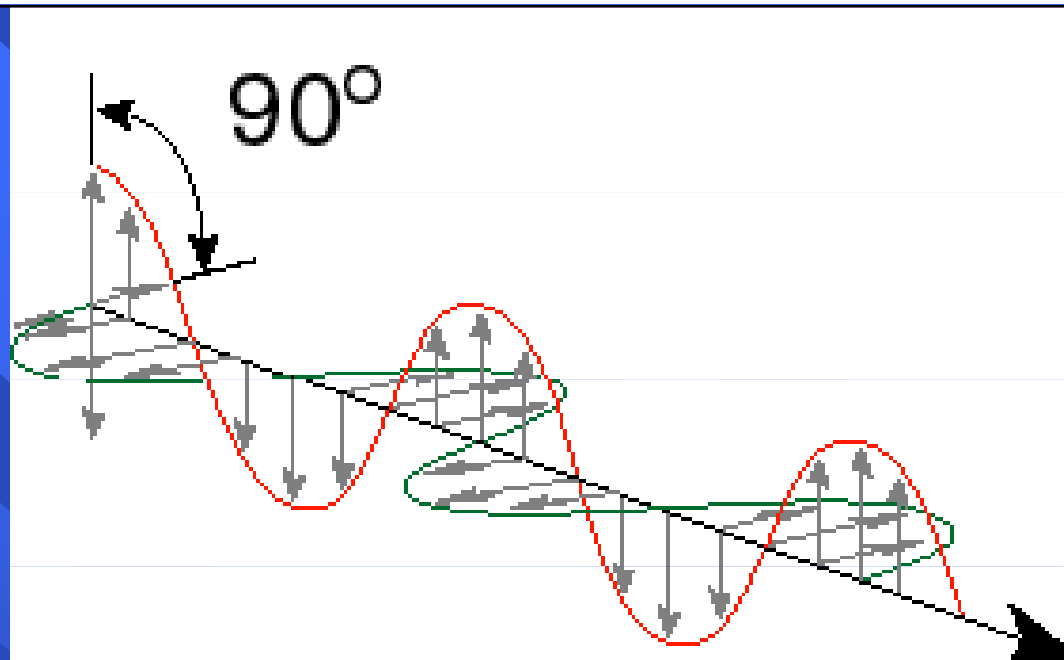

Přirozené světlo lze polarizovat odrazem a lomem, dvojlomem a absorpcí (polaroidy). Odražené světlo je zcela polarizováno pouze při určitém úhlu dopadu (α_B - Brewsterův neboli polarizační úhel, který závisí na indexu lomu

$$n = \operatorname{tg} \alpha_B$$



Optika v klinickém využití

- 1. Odraz
- 2. Lom
- 3. Interference světla
- 4. Difrakce světla
- 5. Polarizace světla
- **6. Koherence vlnění**
- **7. Fluorescence, fosforescence**
- **8. Absorpce, emise stimulovaná emise.**



Lambert - Beerův zákon.

Absorpce

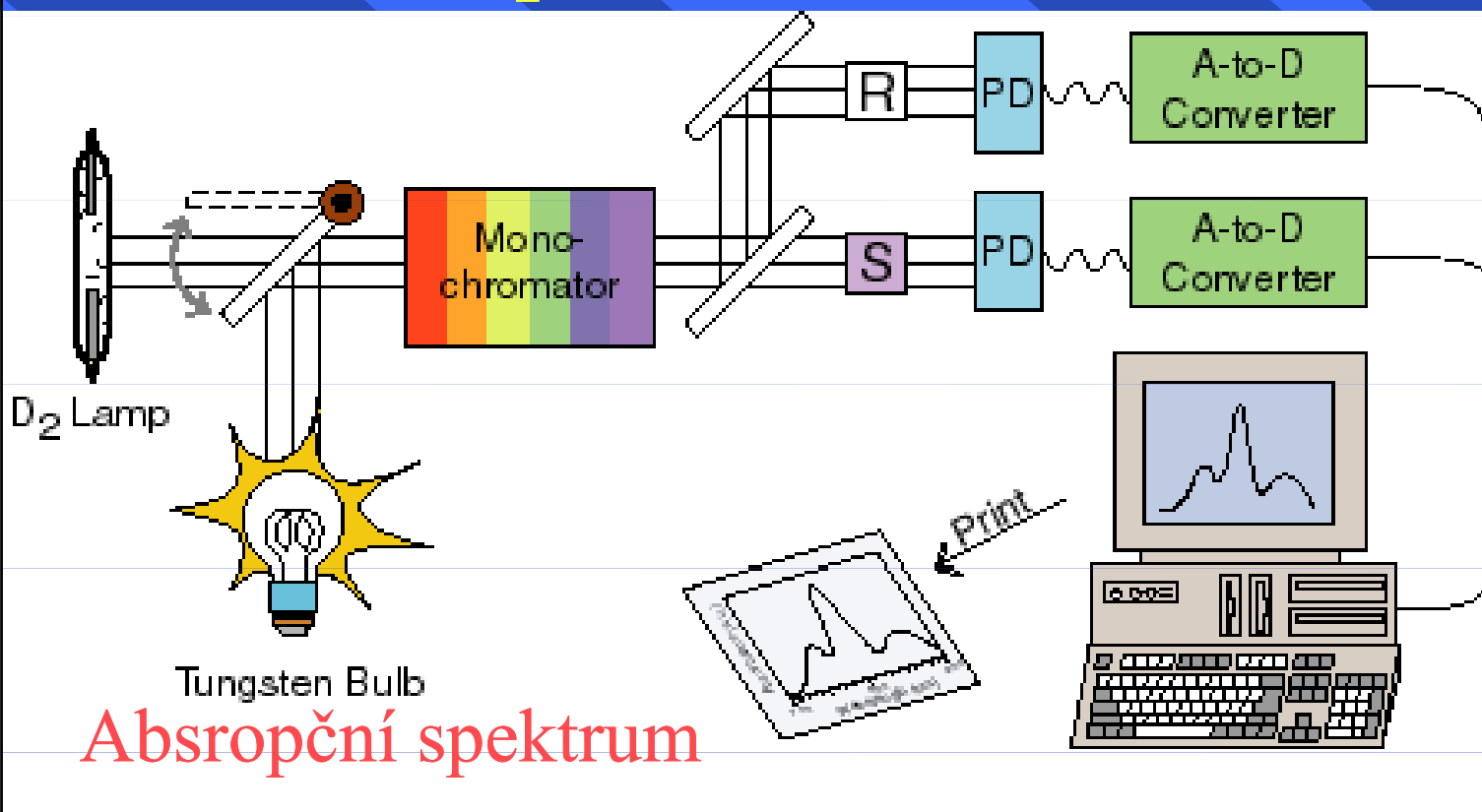

Elektro-
magnetická vlna

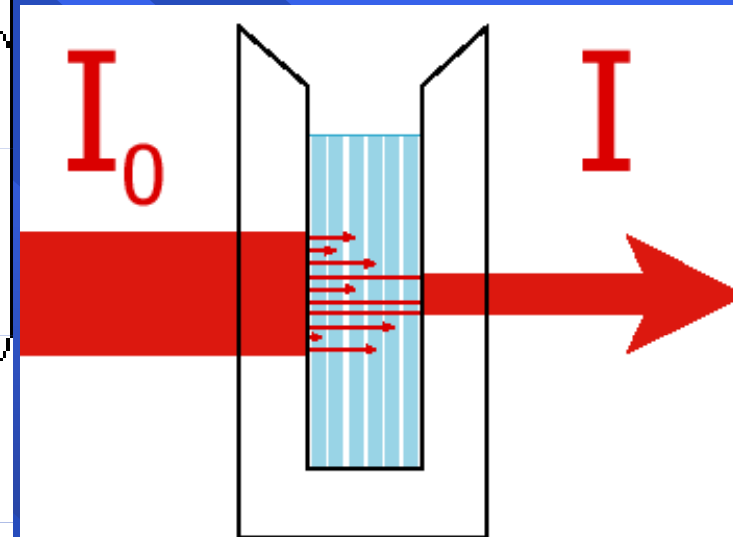

$$\log \frac{I_0}{I} = \epsilon c_m d = \log T$$

$$I = I_0 e^{-\epsilon c_m d}$$

$$E = \epsilon c_m d$$

$$E = -\log T$$

Poměr I/I_0 je transmittance T 

Luminiscence 3

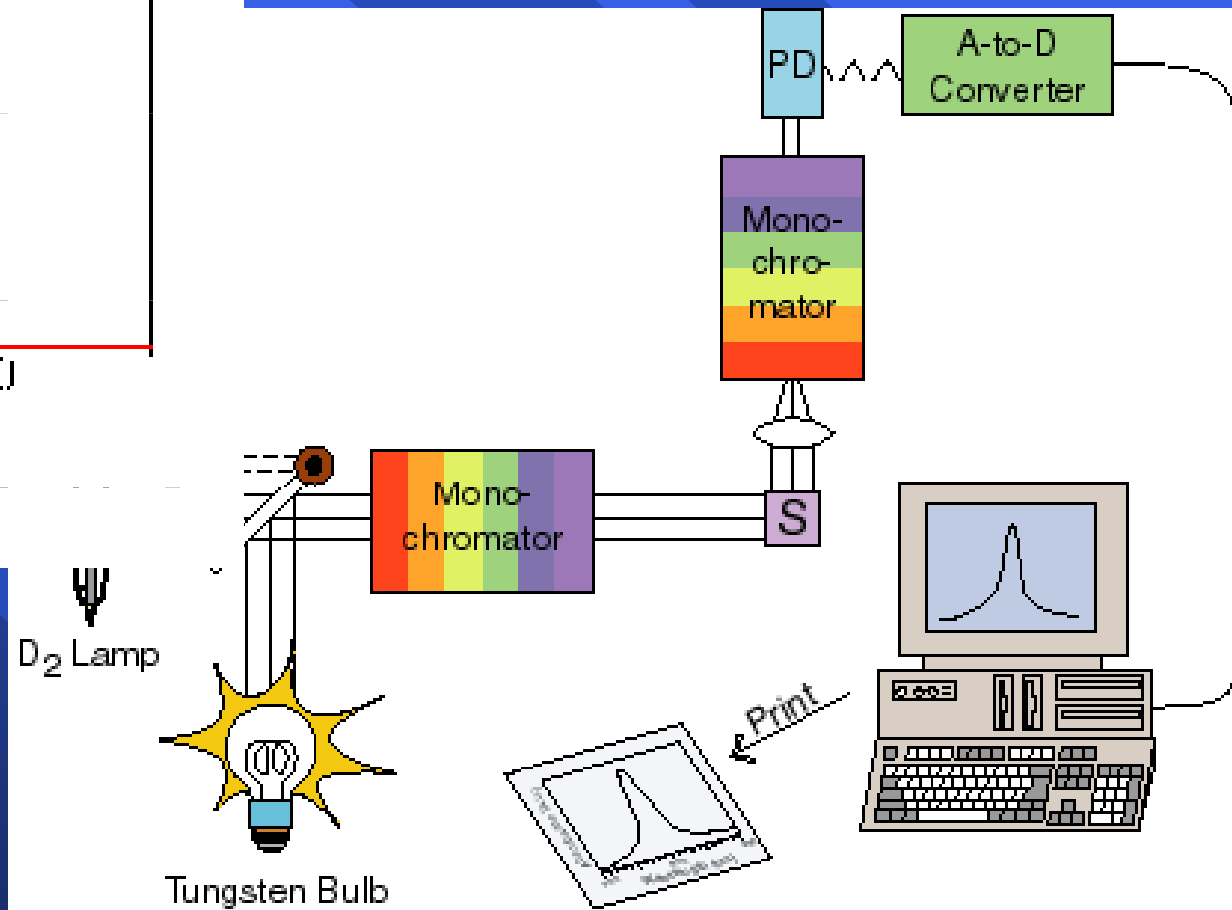
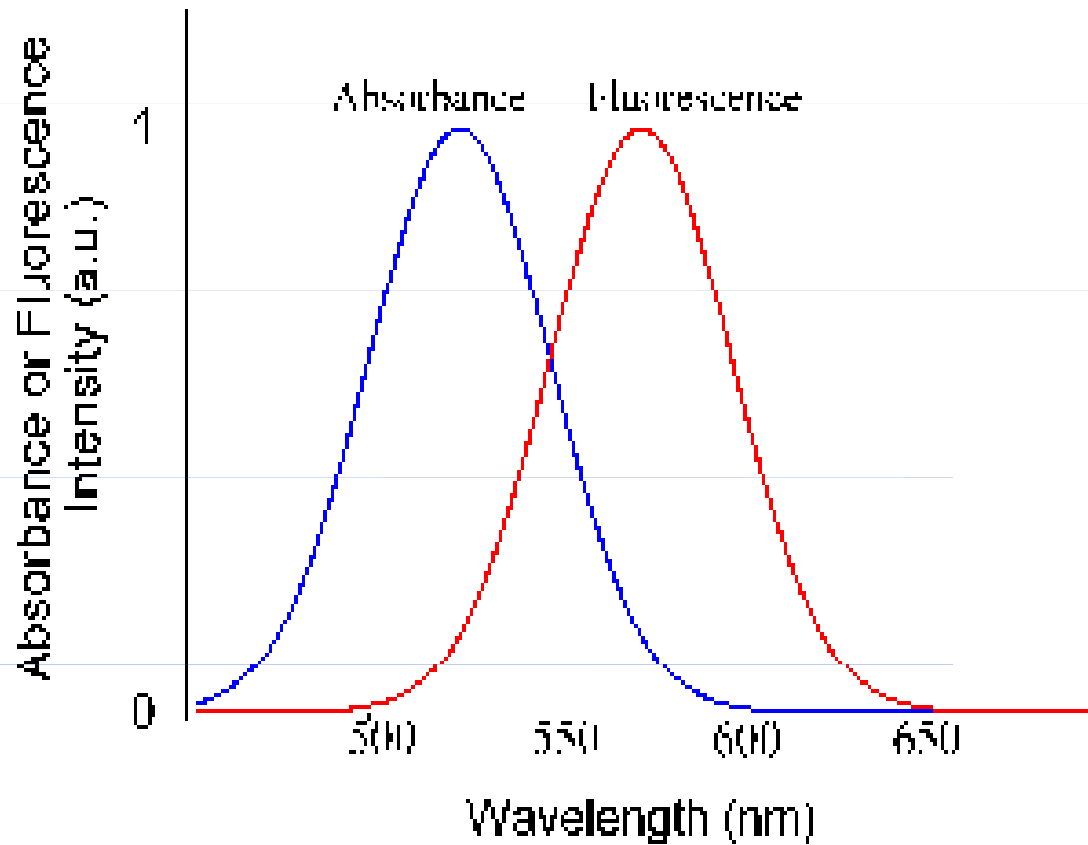

Fluorescence Spectrophotometer



Absorption

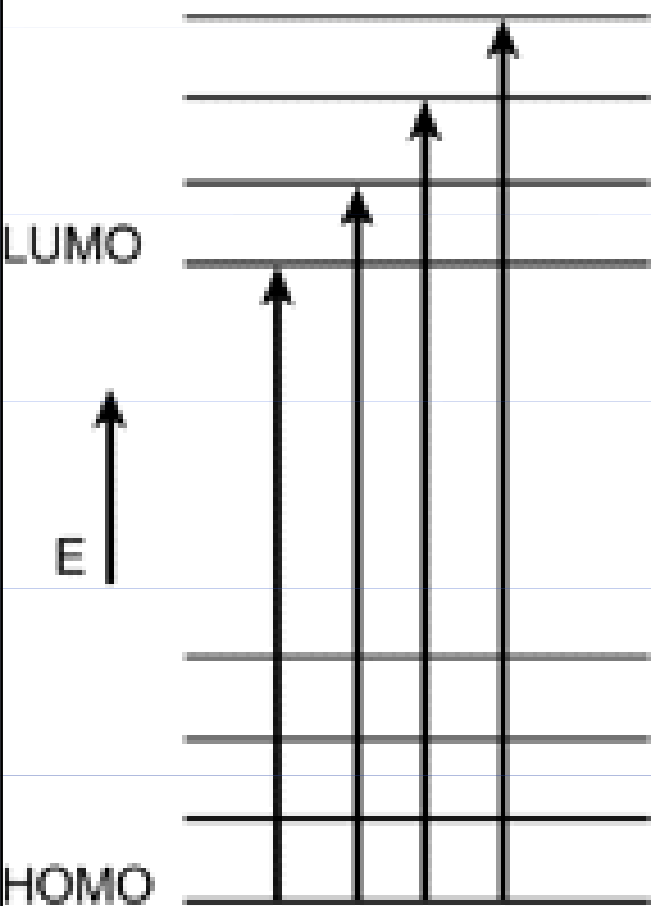

Fluorescence

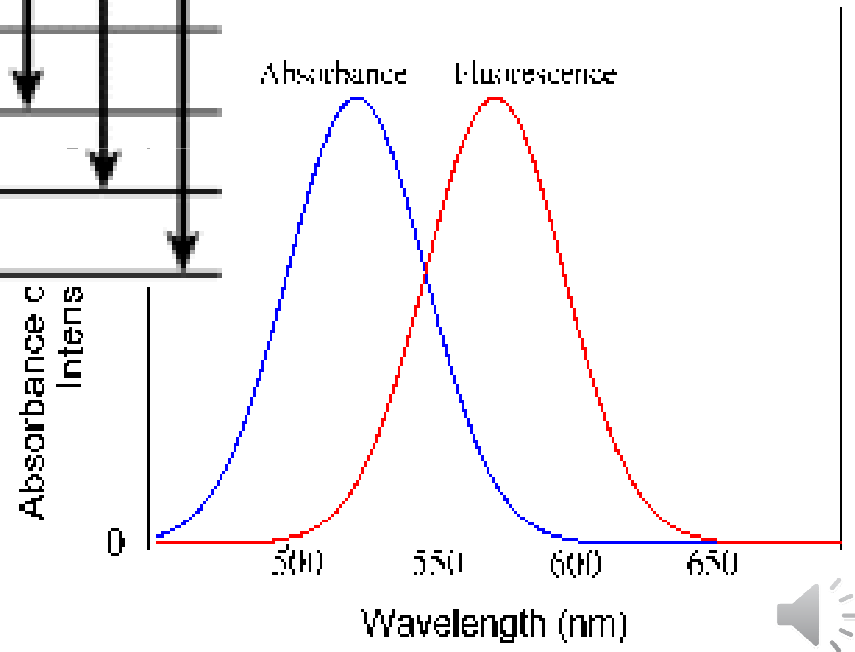
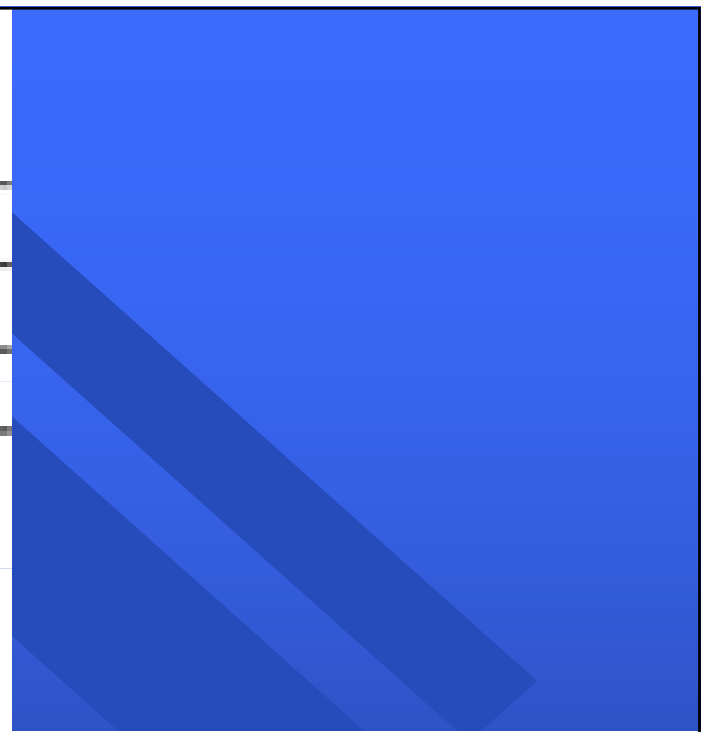
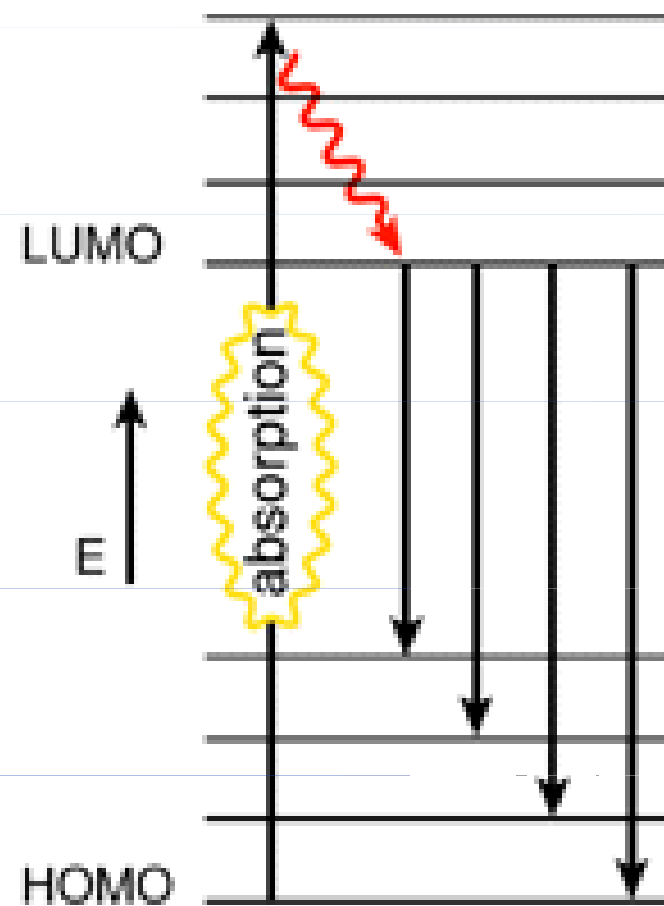



Geometrická optika

$$\frac{1}{a'} + \frac{1}{a} = \frac{1}{f'}$$

■ Dioptrie

■ $D=1/f$

■ *Spojka 1 D má poloměr 2 metry*

$$Z = \frac{y'}{y} = -\frac{a'}{a} = -\frac{a'-f}{f} = -\frac{f}{a-f}$$

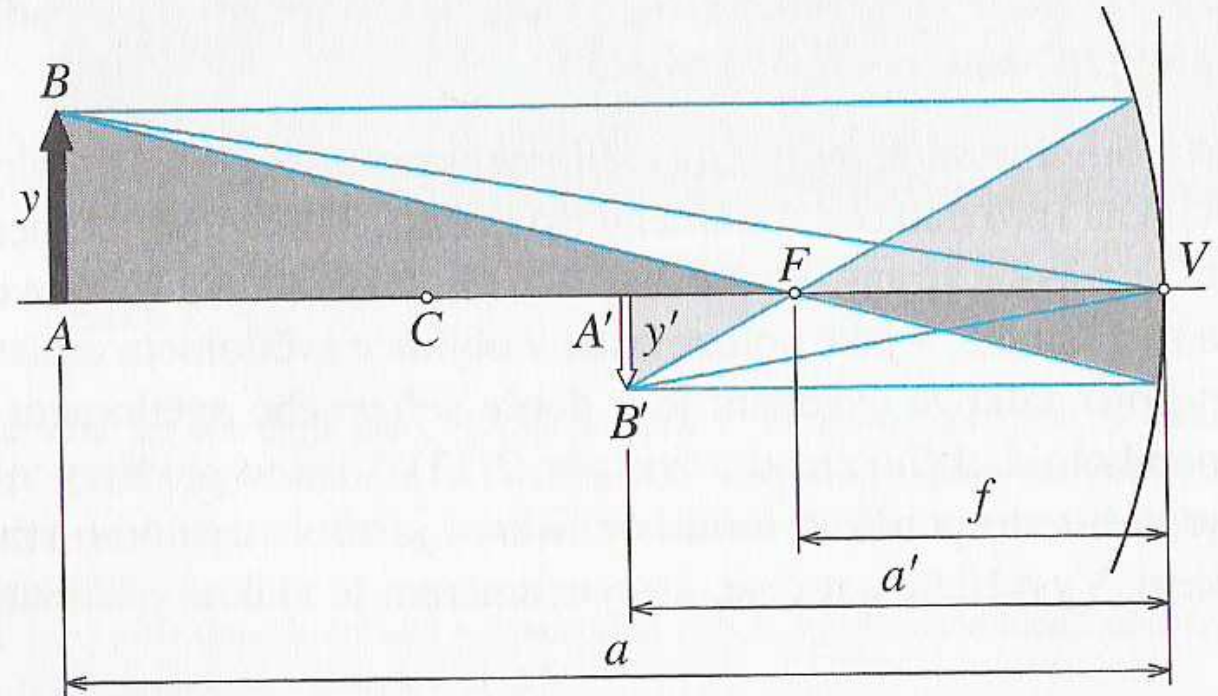

Jednoduchý optický přístroj

camera obscura

přímocharé šíření světla
(stínítko vzdáleno 30 cm od otvoru o průměru 0,8 mm)

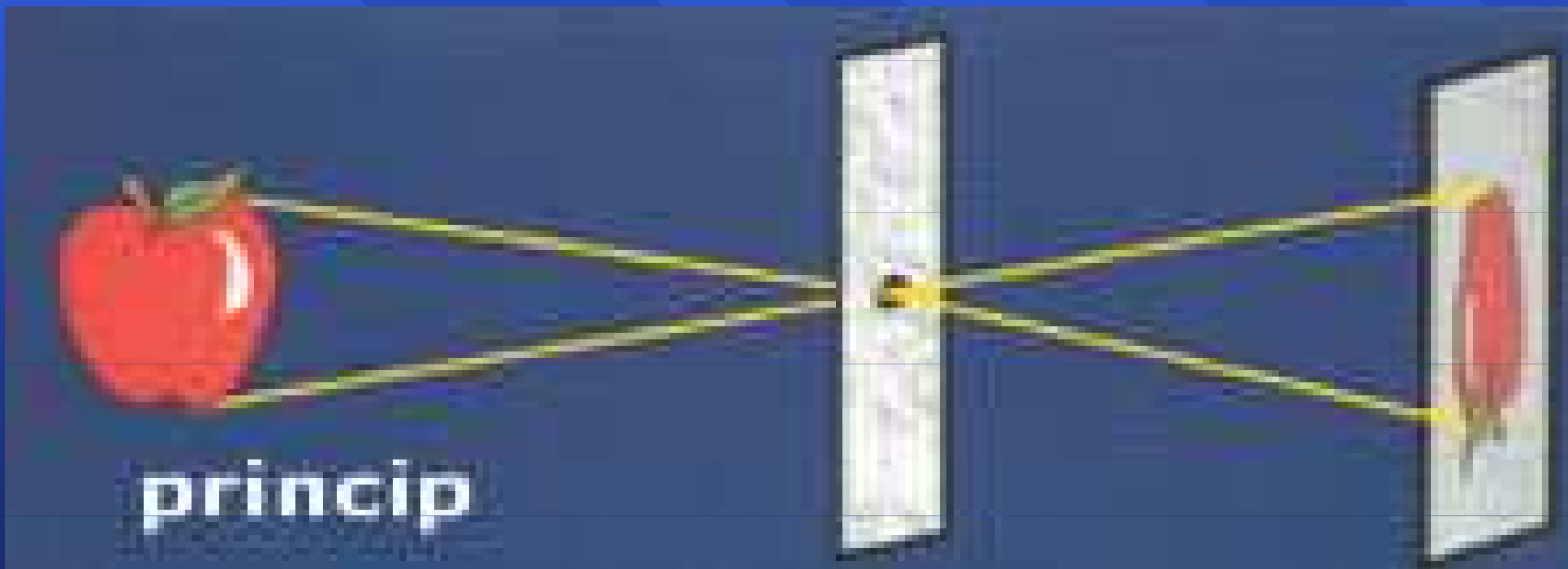

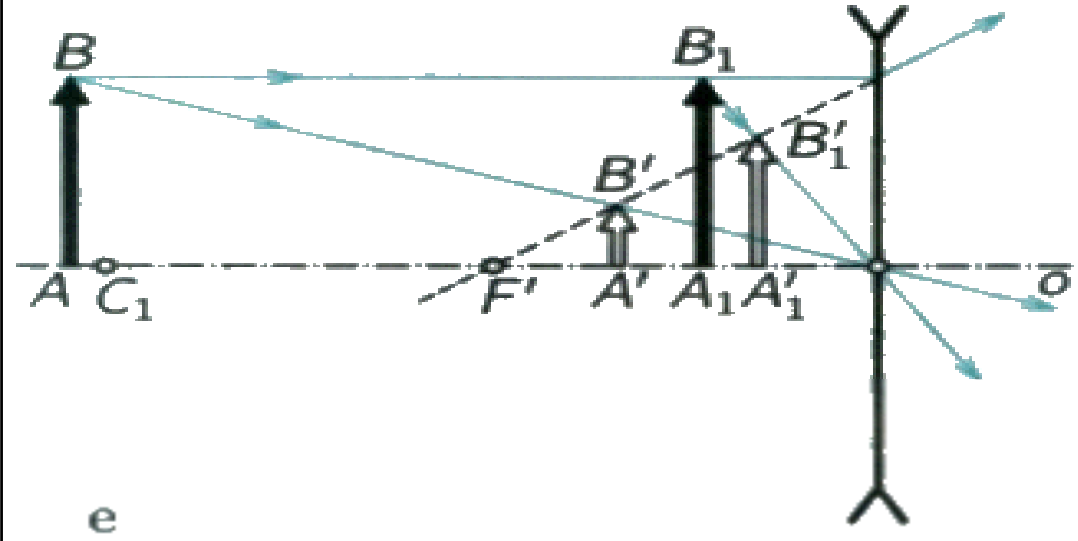
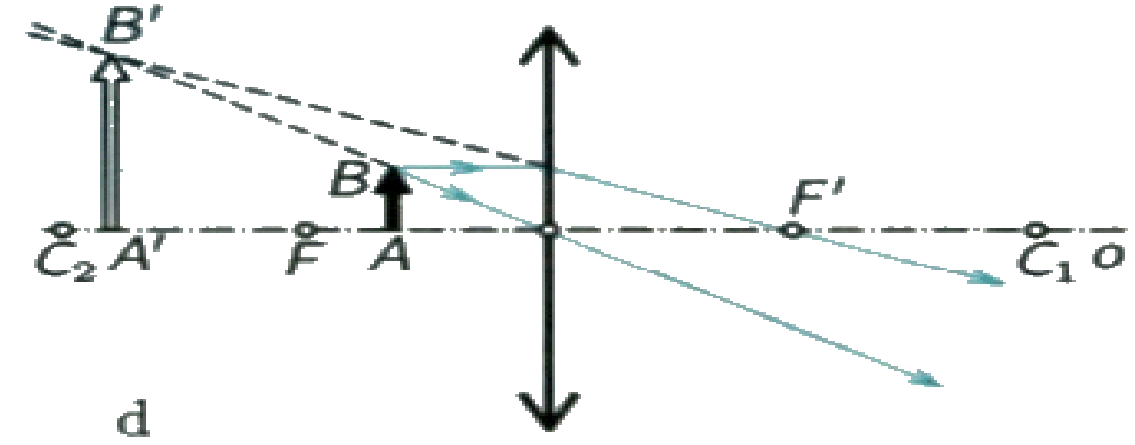
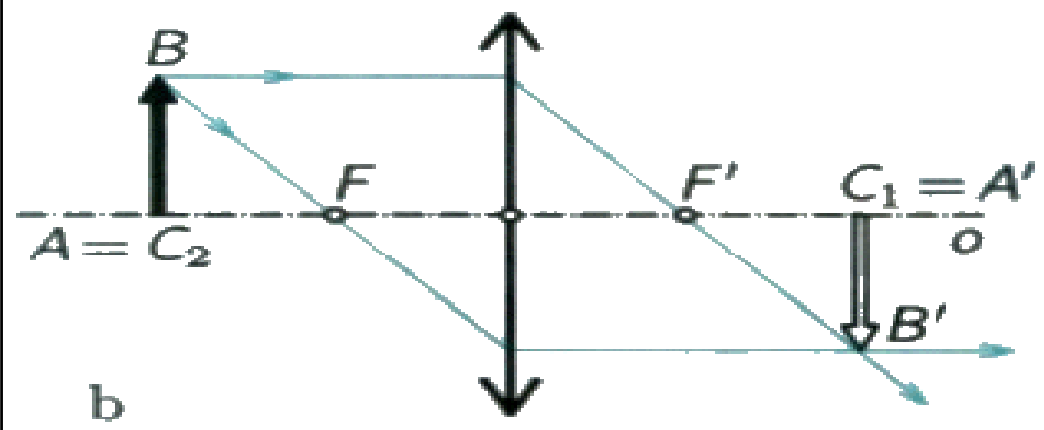
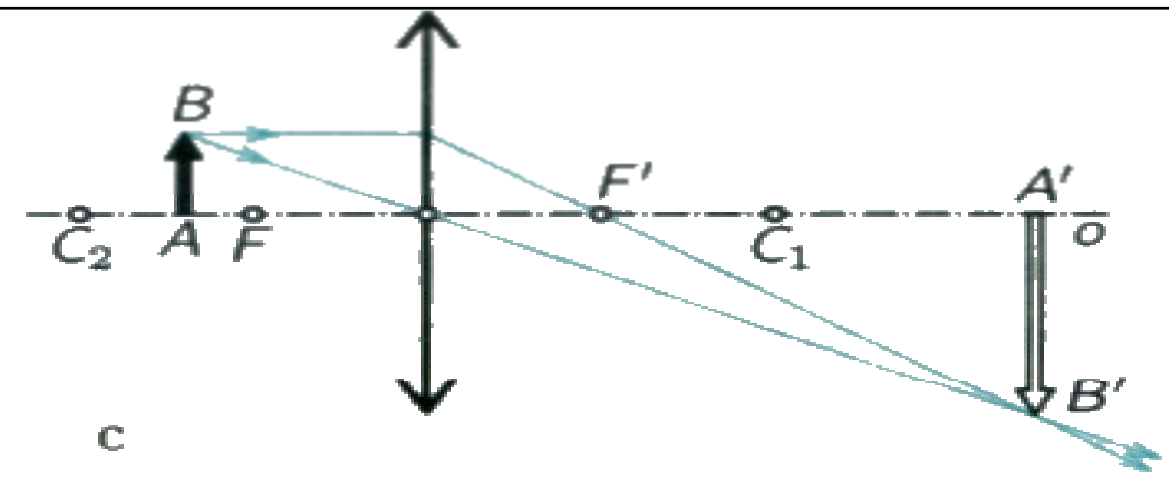
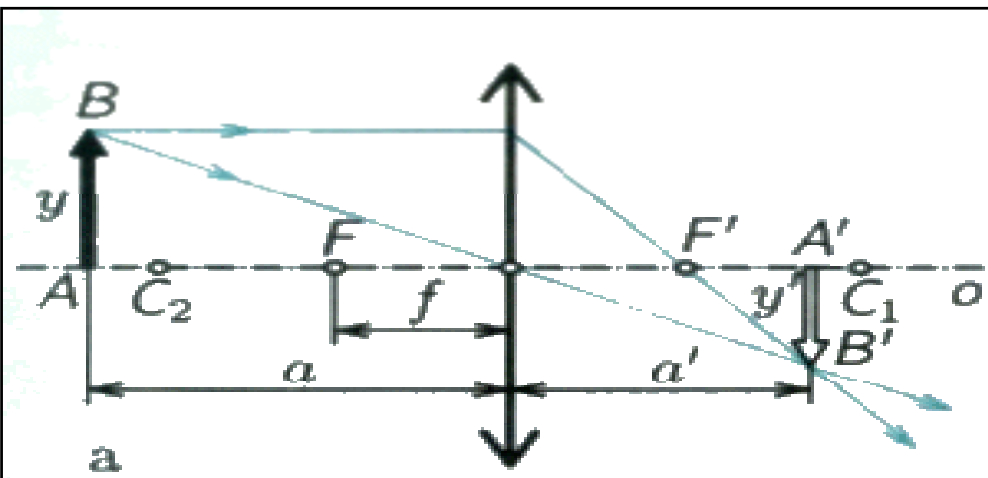

Mikroskop

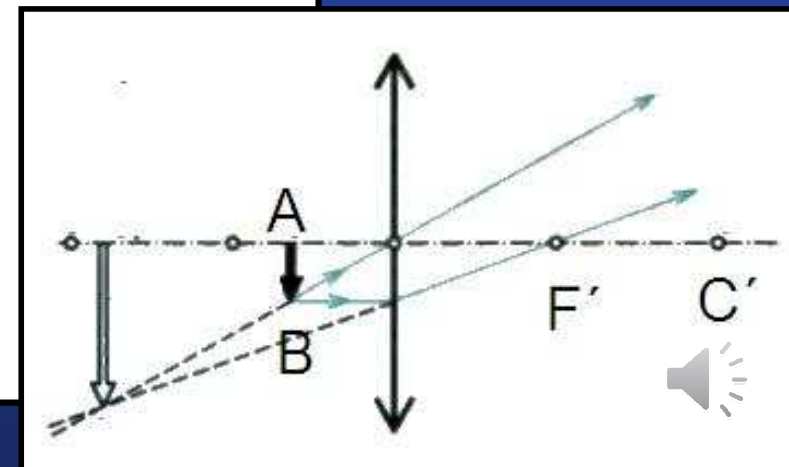
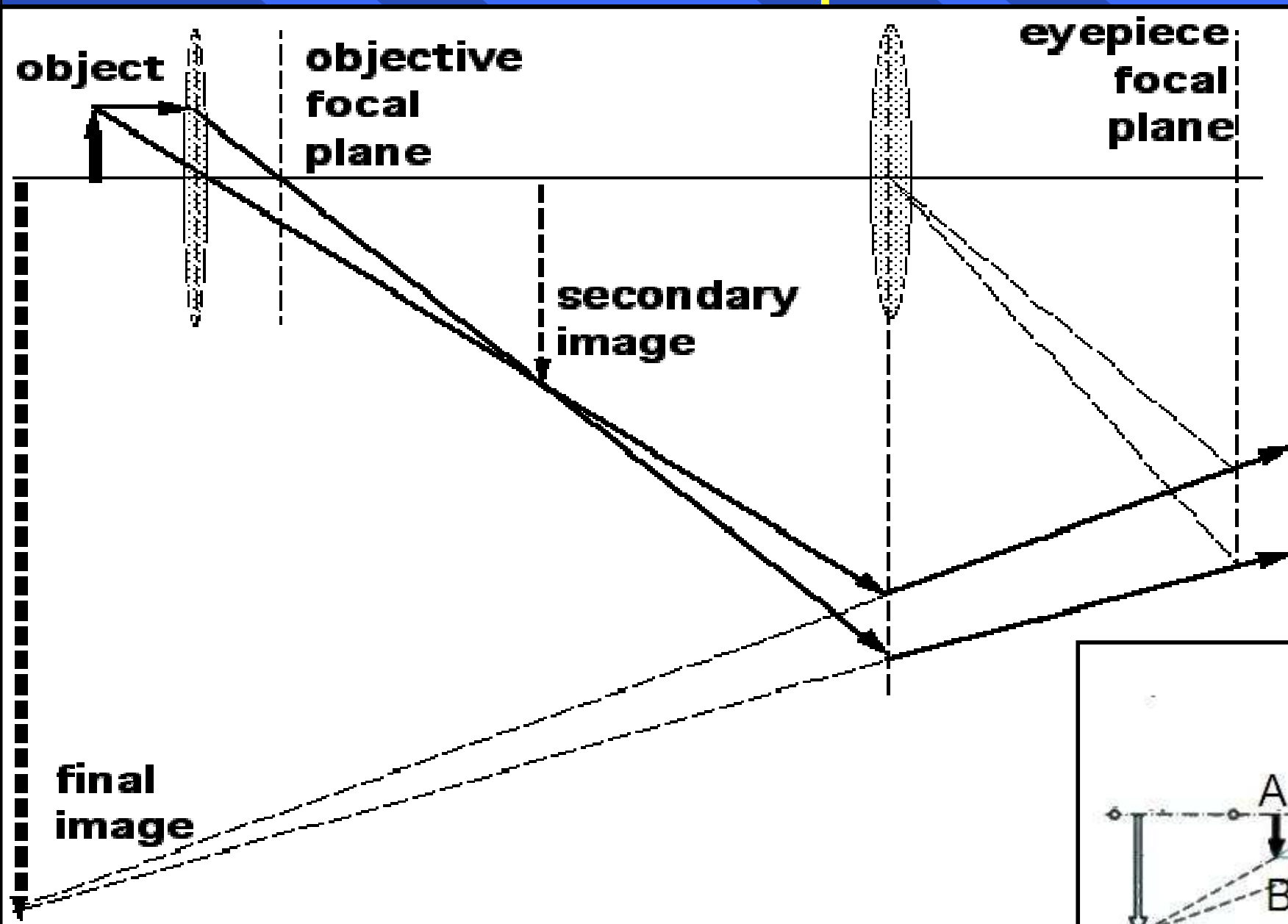

Mikroskop schéma výrobku - digitální

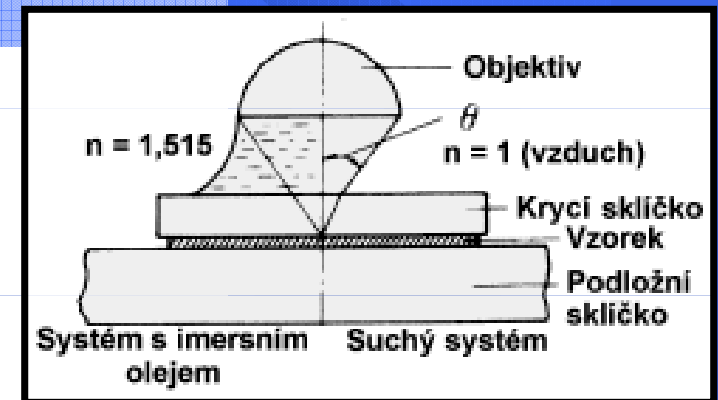
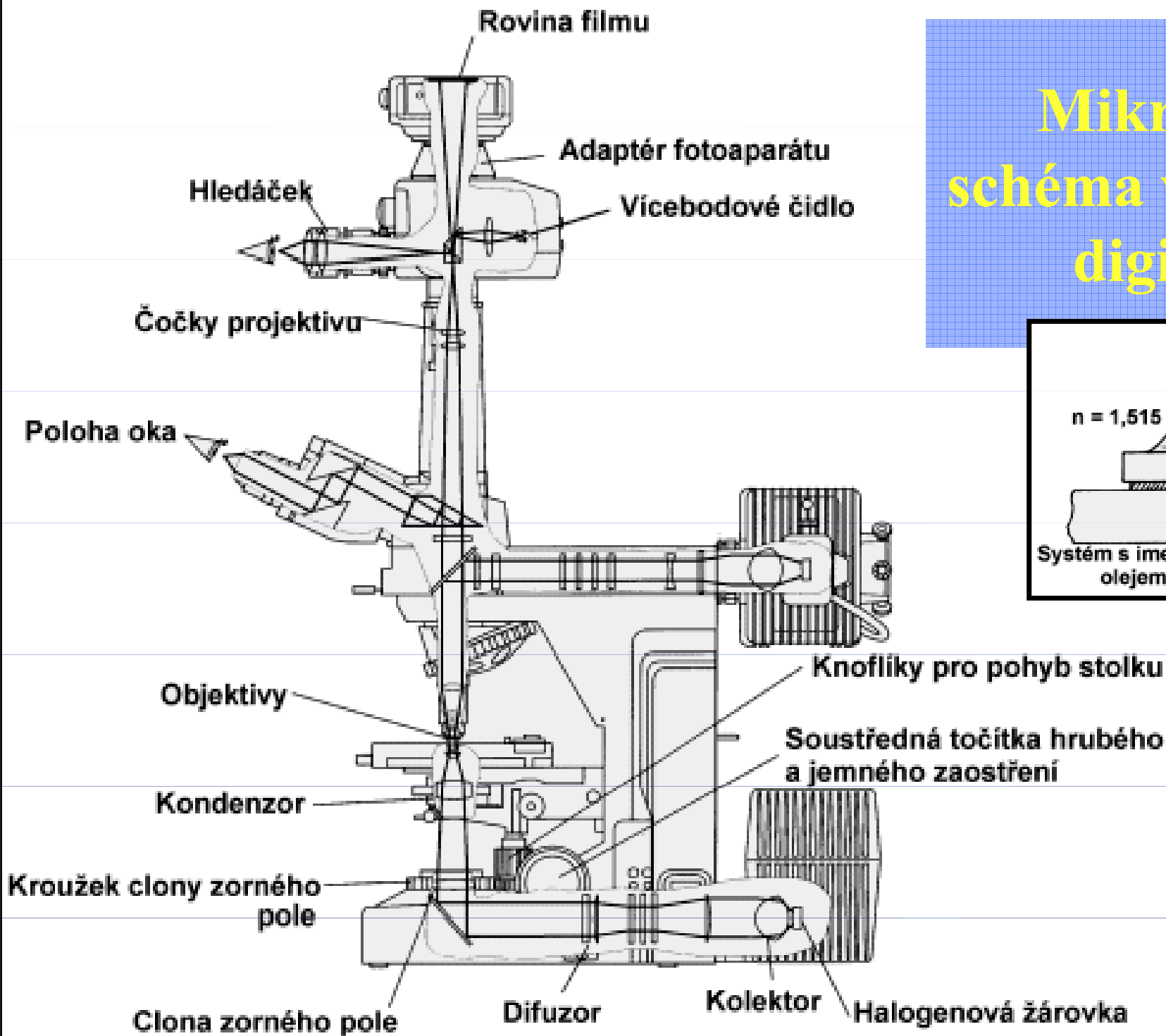

Radio μ waves fIR IR  uV x-ray gamma-ray ...

- Elektromagnetické vlnění s „krátkou“ vlnovou délkou (450 až 700 nm)
- Vlny (čočky a odrazy)
- Částice (fotoelektrická absorpce)

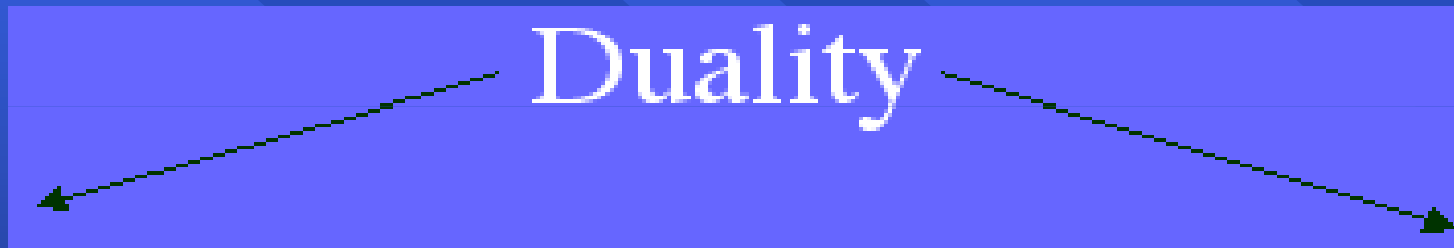

Vlnové vlastnosti

Frekvence a vlnová délka

$$c = \lambda f$$

$$c = 2,97 \times 10^8 \text{ m/s}$$

Částicový popis chování

Energie – hybnost

$$p = h / \lambda = E / c$$

$$h = 6,63 \times 10^{-34} \text{ J/Hz}$$

600nm asi 2eV



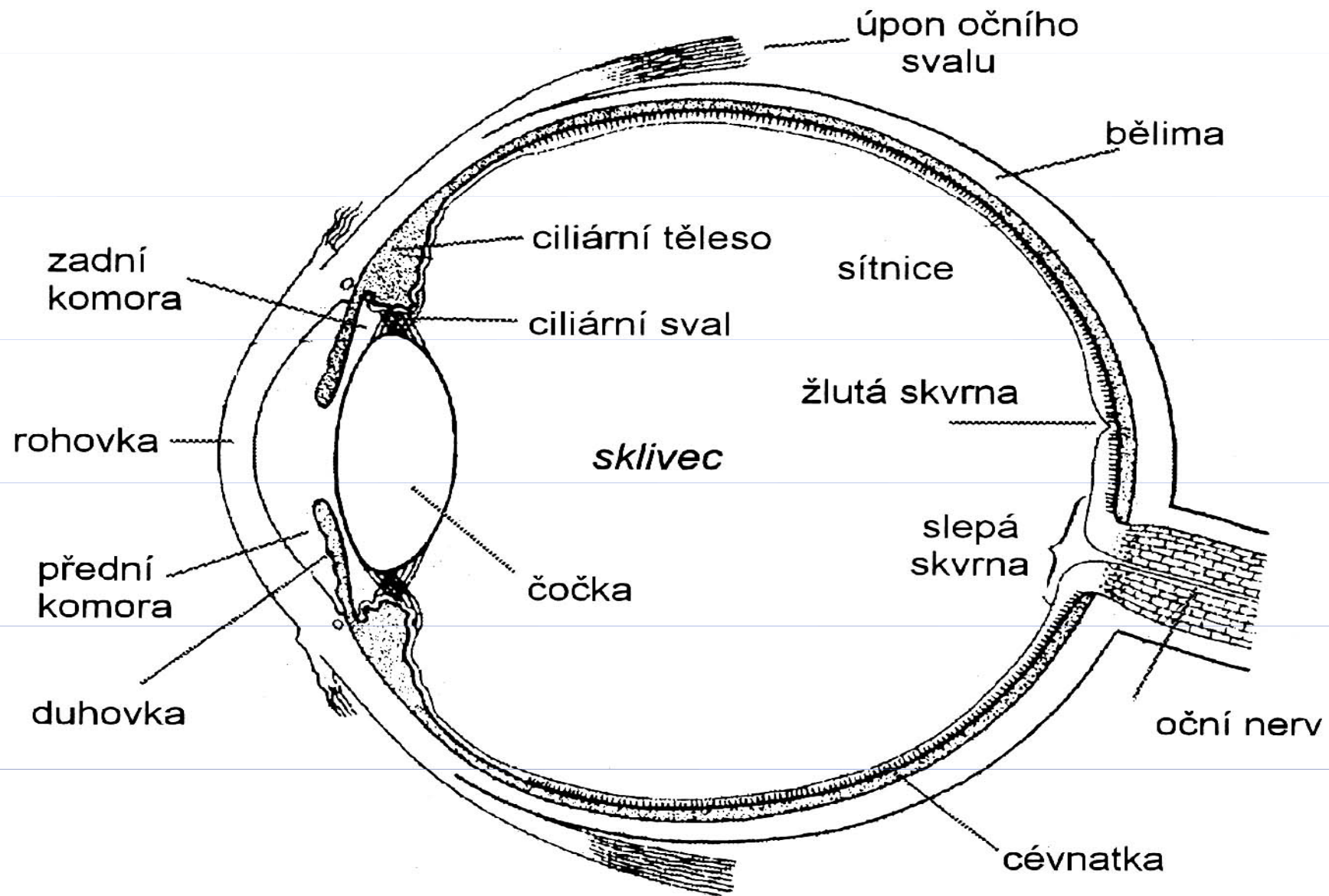

Krátkozrakost a dalekozrakost

Hyperopia

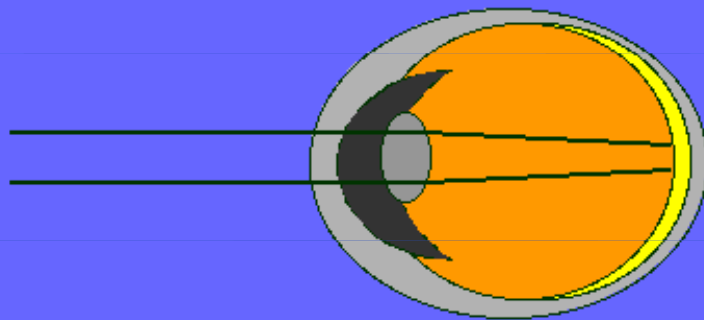

$f > 2$ cm/short eyeball
(or corneal defect)

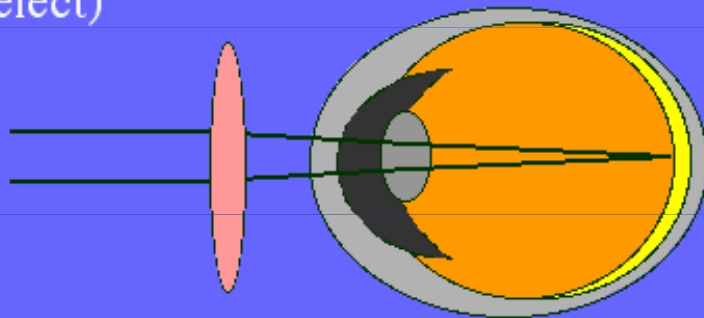

D_{corr} positive (converging lens)

Myopia

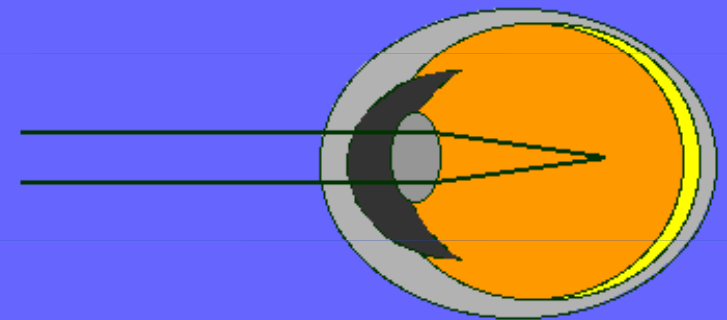

$f < 2$ cm/long eyeball
(corneal defect)

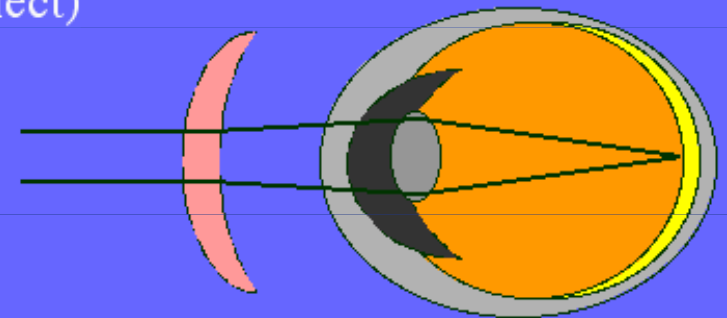

$D_{\text{total}} = D_{\text{eye}} + D_{\text{corr}}$ (D_{corr} is negative)



Zornice a její citlivost

Vidění závisí na barvě a síle

Jde o poměr energie/čas

Otvor se může změnit 7x
v šíři a tedy plocha
50x

Cones provide color vision

Cone opsins:



I_0 (watts/cm²)

A

$$P = I_0 A$$

IRIS



Adaptace na snížení světelné intenzity

- Dynamic range: 50,000
- Pupil increases power only 50x
- Increased photoreceptor chemicals: 1000x

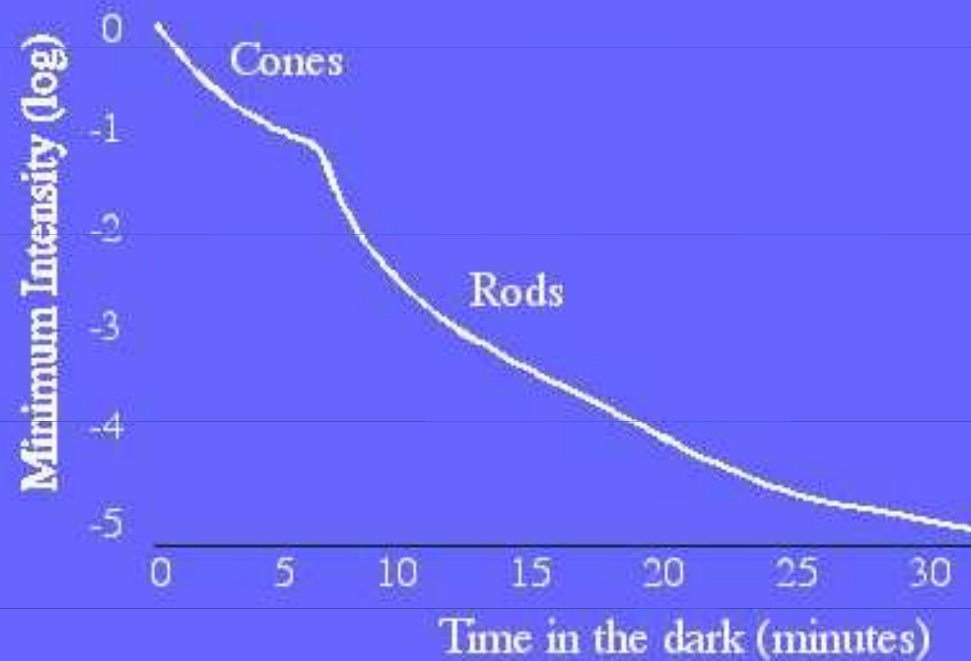

Optické přístroje

Kamera

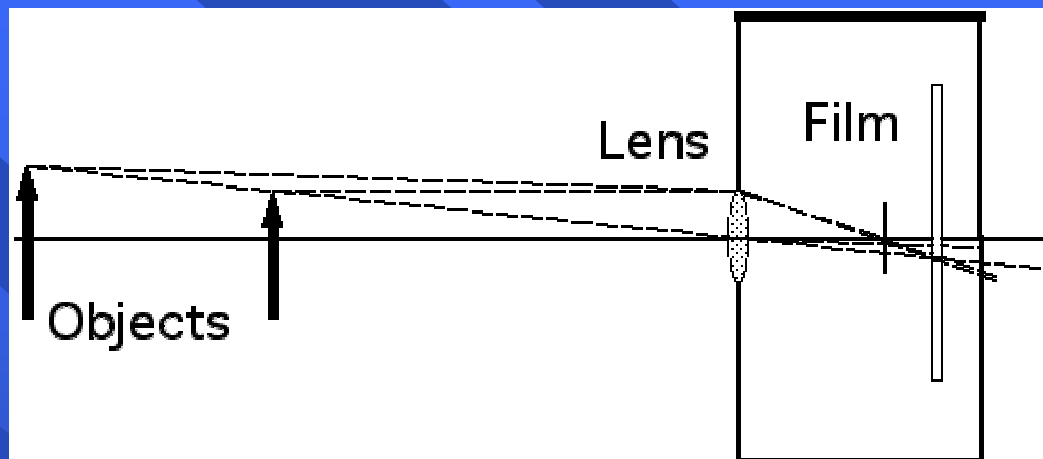

Korekce čoček

